

TOPPAL INTERIOR DOORS 2025-2026



INTERIOR
DOORS

平面款 · 空心門
耐火板 · CW49





CONTENTS

1. Decorating Materials

- Natural Veneer
- Italian Veneer
- Laminate

2. Interior Doors

3. Frames & Moulding

- Lever handle
- Sliding Doors
- Frames

4. Index

德利門 INTERIOR DOORS

木門有不同的材質、大小、做法，拼砌出來風格迥異，以切合各種室內設計風格的需要。除了保護安全、提供私隱度等較實用的用途外，木門在室內裝飾中也扮演著重要的角色。每當走到屋前，最先看到的必然是大門。在推開大門之前，人們往往能憑著對大門的印象，推想屋內的裝潢及風格。步入屋內，房門、浴室門、廚房門等一一陳列在眼前，整個畫面中，少不了木門的存在，配搭得宜，木門與室內的整體裝潢融合在一起，使風格更統一，更完美。

在德利門，我們主力生產於室內用的木門、門框及封口線，經由不同的飾面，包括焗漆、木皮和耐火板，不同的顏色，不同的坑紋設計，致力為客人提供最能配合客人品味的產品。具古典韻味的紅木門、素材感強烈的實木浮雕門、簡單低調的焗漆門，德利門所提供的款式包羅萬有，在琳琅滿目的木門中，希望客人能找到屬於他們的款式。

工藝 CRAFTS

木門的生產工序繁複，一道平面無坑的木門，由門芯的製作，到開料、貼面、修邊、砂光、打吼到組裝，前後要花十多天時間，若是有玻璃、坑線、實木裝飾的木門，所須的手工更多。其他還有更多精細而複雜的小工序，每一個工序都由工匠按客人的要求仔細打造，完成後送往質量檢查，最後的清潔和包裝也一樣小心處理，交到客戶手裡的，都是一件件量身打造的工藝品。

除了工藝，對材料的考究，也是決定每道木門好壞的重要元素。德利門提供多種不同的面料供客人選擇，以配合不同的風格及特式。不同面料的木門生產工序也各不相同，而且各自有它們的優點及限制，工匠們在開始製作每一道木門前都會用心考量，儘量貼近客人的須要。我們的木門廠房由正式投入生產至今已有十四年，多年來設計並生產過無數的木門，連同門框、封口線等的配套，為客人提供最適合的方案。

耐火板木門 CW39 # 3318





PH181
Walnut | 直紋胡桃



S PH182
Walnut | 山紋胡桃



PH071
White Oak | 直紋白橡



A PH091
Birch | 直紋紅櫟



PH111
Sapele | 直紋沙比利



C PH131
Teak | 直紋柚木



PH141
Figured Aniegree | 直紋紅影



A PH151
Oak | 直紋紅橡



PH152
Oak | 山紋紅橡



A PH191
Ash | 直紋栓木



PH192
Ash | 山紋栓木



B PH222
Maple | 山紋楓木



PH221
Maple | 直紋楓木



A PH281
Shaddock | 直紋金絲柚



PA101
Walnut | 巴西胡桃



S PA102
White Oak | 芬蘭白橡



PA106
White Oak | 比利時白橡



S PA112
Maple Strand | 幼紋白楓



PA113
Light Walnut | 林肯淺胡桃



S PA115
Lavender | 幼紋薰衣草



PA116
Walnut | 幼紋胡桃



S PA118
Dark Strand | 幼紋黑絲



PB204
Walnut | 意大利胡桃



S PB210
Autumn Wood | 秋香木



PB211
Teak | 印尼柚木



S PB214
Grey Oak | 幼紋灰橡



B
PB227
Elm | 德國榆木



S **B**
PB228
Red Oak | 德國紅橡



B
PB231
Apricot | 魁北克白克木



S **B**
PB232
Pink Oak | 法國粉橡



B
PC305
Silver Oak | 法國銀橡



S **B**
PC309
Ginkgo Biloba | 法國白杏木



B
PC311
Finline Silver Oak | 幼紋銀橡



S **C**
PC324
Lavender | 法國薰衣草



C
PC320
Walnut | 德國胡桃



S **C**
PC321
Lavender | 日本薰衣草

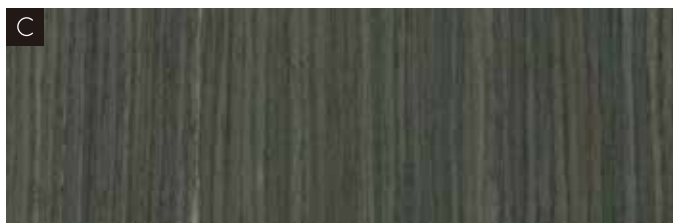

C
PC322
Lavender | 德國薰衣草



S **C**
PC323
Lavender | 美國薰衣草



CW39



S G494

S



CW146



C CW95

S



FA25



S CW32

C



DH304



PG DH303

PG



DH310

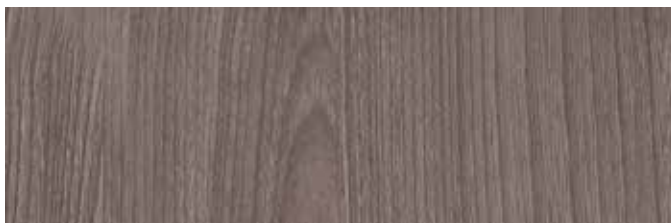

PG CW132

S



CW77

S



YD3857



S YC3107

S



YD3709



C YD3633

S

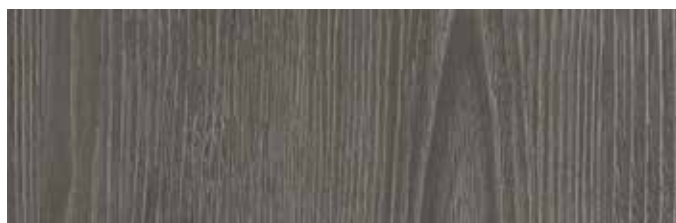

YD3646



C YD3645

C

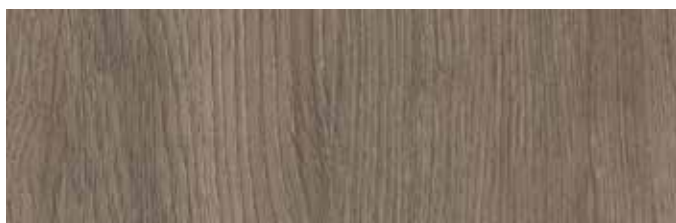

YD3854



S YD3701

C



YD3851



C YD3852

C



YC3168



S YC3130

S

木門 DOORS

木門用在不同的環境中發揮不同的作用，亦會因此有不同的規格及要求。簡單來說木門會歸類為空心門、實心門或實木門。

空心門多用於空間之間的間隔，如房門、浴室門等。空心門的門心以較輕的材料製作，所以重量較輕，拉起來比較省力，同時起到一定的隔音效果。實心門的門心會以木坊作填充，所以重量非常重，也相對會較厚，多用作大門。實心門具有更強的隔音效果，厚重的大門也提供保護房子的功能，但實心門一般不設防火，我們可按客戶要求，製作附合消防條列的防火實心門。實木門在本地市場中比較少見，指的整道木門都以原木製造，重量更重，價格更昂貴。德利門所生產的實木門採用天然松木，松木本身較其他木種輕，木紋清晰強烈，適合使用於實木門。

木門亦可分為拉門或趟門，傳統做法以拉門為主，近年亦流行暗門的做法，省去門框及封口線，木門與牆身平排，強調出室內裝潢的簡約及利落感。趟門能有效地節省空間，省去推拉門開關時佔用的空間，趟門開合時也較為安靜。

*Colours shown in this catalog could be different to the actual product due to printing quality

*此樣板書內圖片只供參考，實物顏色與圖片可能會因本刊印刷品質而產生差異

淨色焗漆木門 深灰色 # 5504





2014
面料 | 淨色焗漆 白油



2015
面料 | 淨色焗漆 白油



2017
面料 | 淨色焗漆 白油



2019
面料 | 淨色焗漆 白油

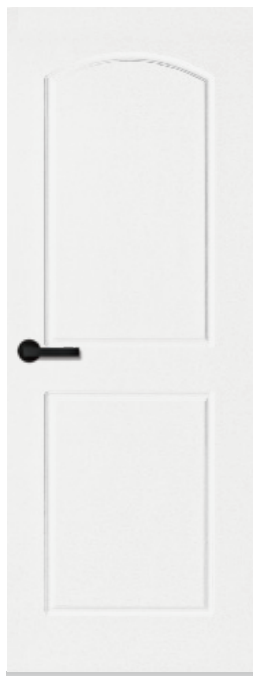

2028
面料 | 淨色焗漆 白油



2030
面料 | 淨色焗漆 白油



2031
面料 | 淨色焗漆 白油



2032
面料 | 淨色焗漆 白油



2049
面料 | 淨色焗漆 白油



2050
面料 | 淨色焗漆 白油

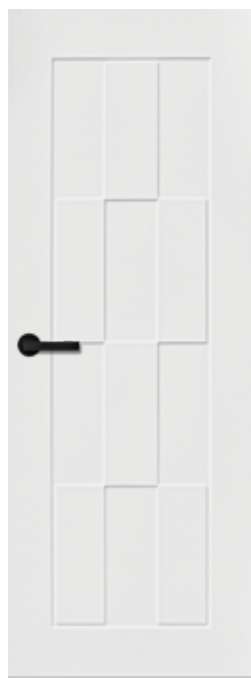

2054
面料 | 淨色焗漆 白油



2070
面料 | 淨色焗漆 白油



2075
面料 | 淨色焗漆 白油



2076
面料 | 淨色焗漆 白油



2080
面料 | 淨色焗漆 白油



2082
面料 | 淨色焗漆 白油



2083
面料 | 淨色焗漆 白油



2084
面料 | 淨色焗漆 白油



2085
面料 | 淨色焗漆 白油



2086
面料 | 淨色焗漆 白油



2093
面料 | 淨色焗漆 白油



2100
面料 | 淨色焗漆 白油



2105
面料 | 淨色焗漆 白油



2107
面料 | 淨色焗漆 白油



2108
面料 | 淨色焗漆 白油



2110
面料 | 淨色焗漆 白油



2111
面料 | 淨色焗漆 白油



2112
面料 | 淨色焗漆 白油



2113
面料 | 淨色焗漆 白油

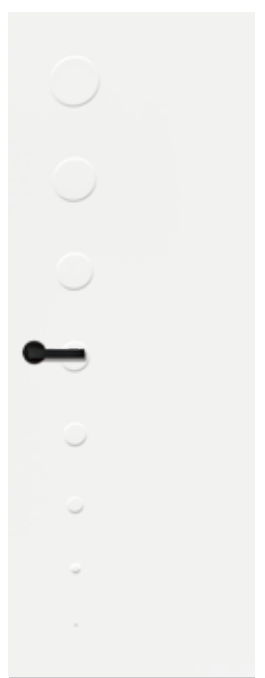

2114
面料 | 淨色焗漆 白油



2115
面料 | 淨色焗漆 白油

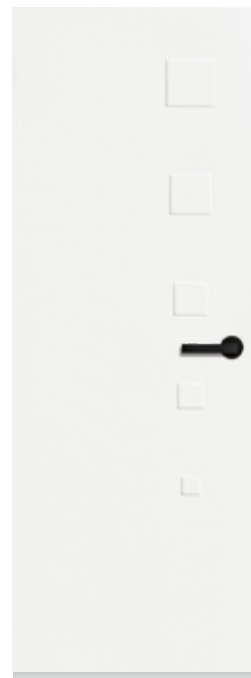

2116
面料 | 淨色焗漆 白油



2117
面料 | 淨色焗漆 白油



2118
面料 | 淨色焗漆 白油



2124
面料 | 淨色焗漆 白油



2126
面料 | 淨色焗漆 白油



3004
面料 | 淨色焗漆 白油

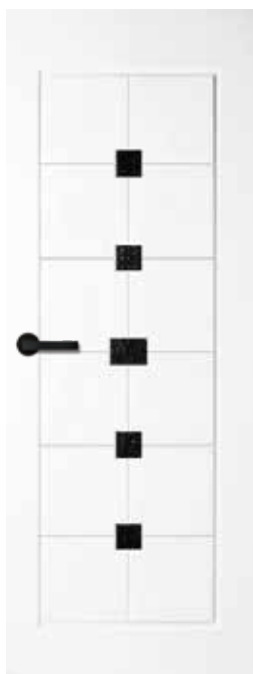

3009
面料 | 淨色焗漆 白油
| 配人造石

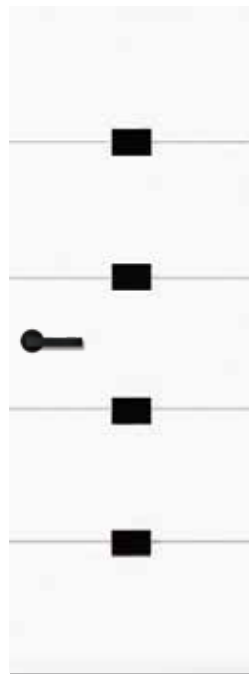

3010B
面料 | 淨色焗漆 白油
| 配灰鏡



3019
面料 | 淨色焗漆 白油
| 配LA102



3033
面料 | 淨色焗漆 白油
| 配合金飾條



3037
面料 | 淨色焗漆 白油



3065
面料 | 淨色焗漆 白油



3067
面料 | 淨色焗漆 白油



3077
面料 | 淨色焗漆 白油

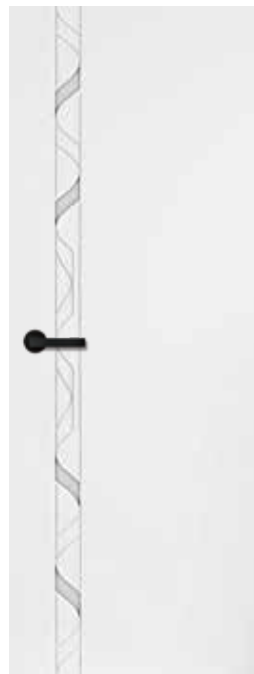

3094
面料 | 淨色焗漆 白油
| 配不鏽鋼鏡



3099
面料 | 淨色焗漆 白油



3501
面料 | 實木 白油
| 浮雕芬蘭松木



3502
面料 | 實木 白油
| 浮雕芬蘭松木



3505
面料 | 實木 白油
| 浮雕芬蘭松木



3509
面料 | 實木 白油
| 浮雕芬蘭松木



3512
面料 | 實木 白油
| 浮雕芬蘭松木



3514
面料 | 實木 白油
| 浮雕芬蘭松木



3515
面料 | 實木 白油
| 浮雕芬蘭松木



3516
面料 | 實木 白油
| 浮雕芬蘭松木



4051
面料 | 淨色焗漆 白油
| 配WPC01木塑板

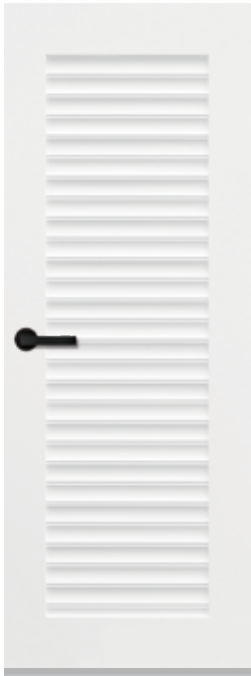

4052
面料 | 淨色焗漆 白油
| 配WPC01木塑板

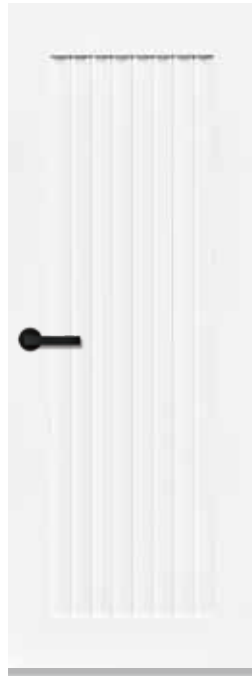

4053
面料 | 淨色焗漆 白油
| 配WPC01木塑板



5034
面料 | 淨色焗漆 白油



5038
面料 | 淨色焗漆 白油



6038
面料 | 淨色焗漆 白油



6053
面料 | 淨色焗漆 白油



6054
面料 | 淨色焗漆 白油



6063
面料 | 淨色焗漆 白油



3052
面料 | 淨色焗漆 白油
| 配彩印安全玻璃



3053
面料 | 淨色焗漆 白油
| 配彩印安全玻璃



3054
面料 | 淨色焗漆 白油
| 配彩印安全玻璃



3055
面料 | 淨色焗漆 白油
| 配彩印安全玻璃

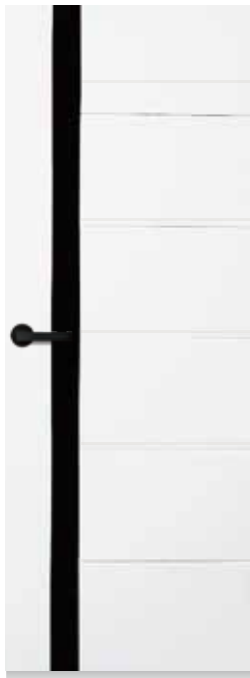

3040
面料 | 淨色焗漆 白油
| 配黑油玻璃



3075
面料 | 淨色焗漆 白油
| 配白油通花黑油玻璃



3078
面料 | 淨色焗漆 白油
| 配黑油玻璃

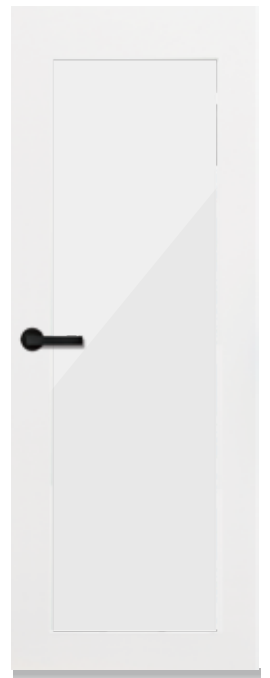

8112
面料 | 淨色焗漆 白油
| 開窗配清片玻璃



8129
面料 | 淨色焗漆 白油
| 配清片玻璃

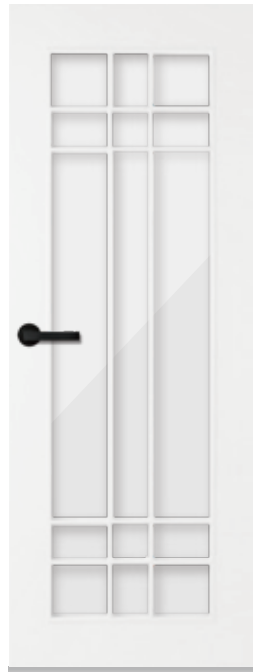

8148
面料 | 淨色焗漆 白油
| 配砂片玻璃

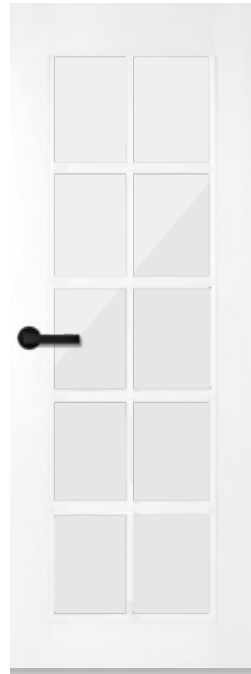

8110
面料 | 淨色焗漆 白油
| 開窗配砂片玻璃



8111C
面料 | 淨色焗漆 白油
| 開窗配彩砂玻璃

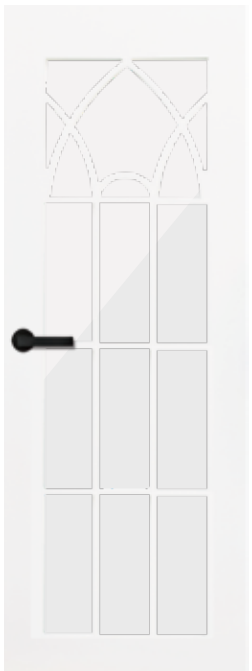

8199
面料 | 淨色焗漆 白油
| 開窗配砂片玻璃



8200
面料 | 淨色焗漆 白油
| 配清片玻璃

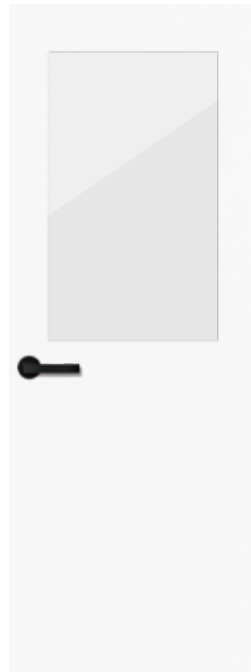

8120
面料 | 淨色焗漆 白油
| 開窗配清片玻璃

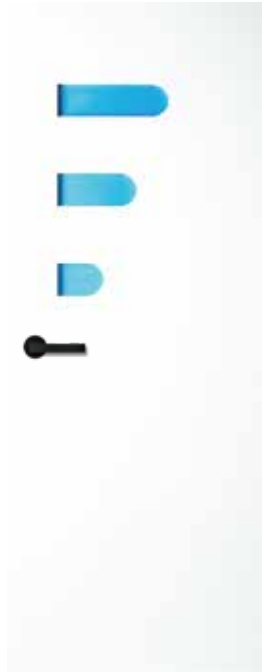

8123
面料 | 淨色焗漆 白油
| 開窗配彩砂玻璃



8146
面料 | 淨色焗漆 白油
| 配砂片玻璃

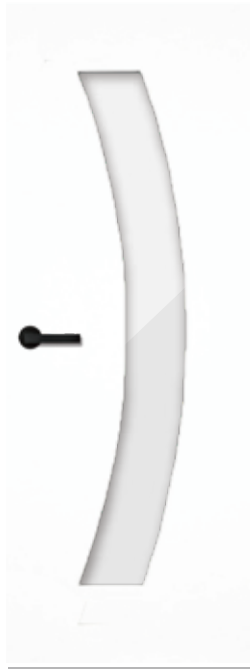

8134
面料 | 淨色焗漆 白油
| 配砂片玻璃



8117
面料 | 淨色焗漆 白油
| 配清片玻璃



8122
面料 | 淨色焗漆 白油
| 配清片玻璃

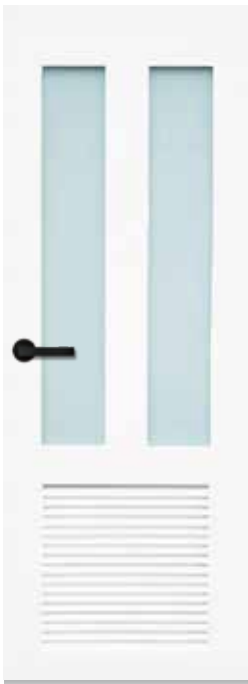

8154
面料 | 淨色焗漆 白油
| 配砂片玻璃
| 配回風



8218
面料 | 淨色焗漆 白油
| 配清片玻璃
*子母門



8219
面料 | 淨色焗漆 白油
| 配清片玻璃
*子母門

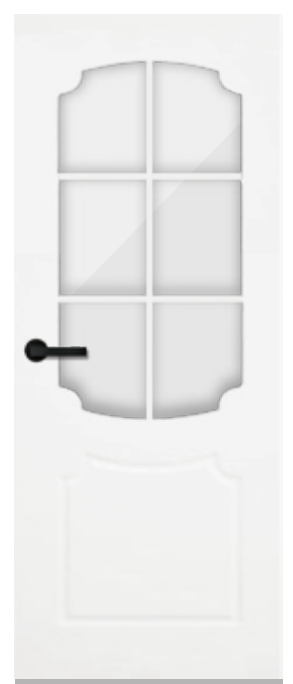

8169
面料 | 淨色焗漆 白油
| 配清片玻璃



8221
面料 | 淨色焗漆 白油
| 配兩件超白白油玻璃

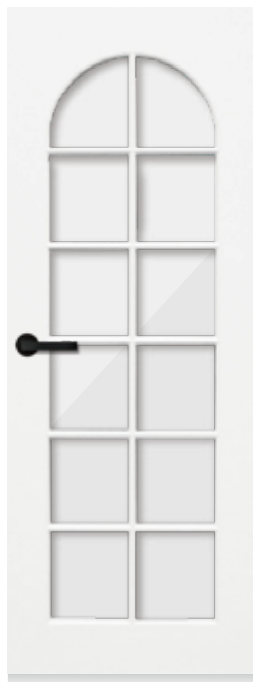

8137
面料 | 淨色焗漆 白油
| 配清片玻璃

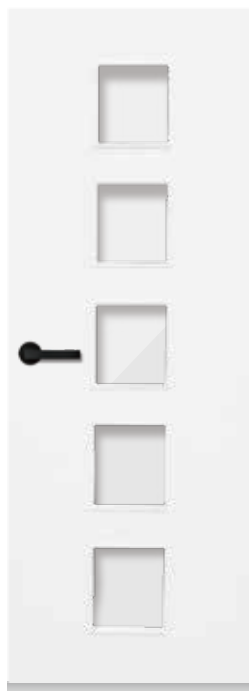

8128
面料 | 淨色焗漆 白油
| 配清片玻璃



8201
面料 | 淨色焗漆 白油
| 配清片玻璃



8118
面料 | 淨色焗漆 白油
| 配清片玻璃



8300
面料 | 淨色焗漆 白油
| 配灰玻·平窗線



8119
面料 | 淨色焗漆 白油
| 配清片玻璃·凸窗線



8302
面料 | 淨色焗漆 白油
| 配光片黑油玻璃

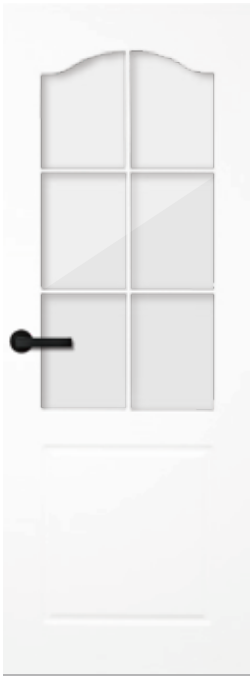

8170
面料 | 淨色焗漆 白油
| 配清片玻璃



8130
面料 | 淨色焗漆 白油
| 配砂片玻璃



3513
面料 | 實木 白油
| 浮雕芬蘭松木
| 配清片玻璃



3517
面料 | 實木 白油
| 浮雕芬蘭松木
| 配秋葉玻璃

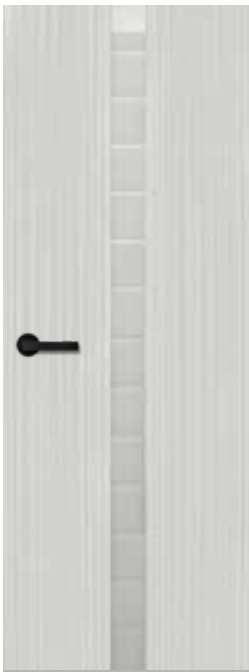

3305
面料 | 耐火板
| D721
| 配斜邊超白白油玻璃



3305
面料 | 耐火板
| CW135
| 配斜邊銀鏡玻璃



3303
面料 | 耐火板
| D732
| 配砂片玻璃

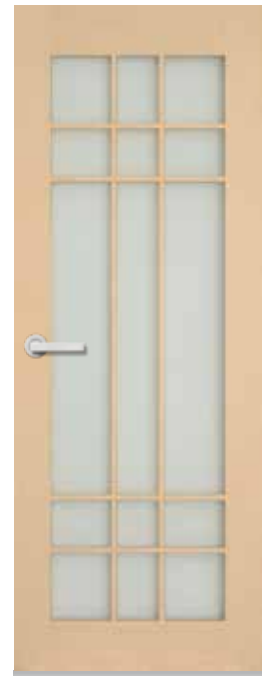

8148
面料 | 木皮 原色上油
| 芬蘭白橡 PA102
| 配砂片玻璃



3351
面料 | 耐火板
| FA20
| 配秋葉玻璃



8140
面料 | 木皮 原色上油
| 直紋紅櫟
| 開窗配工藝玻璃

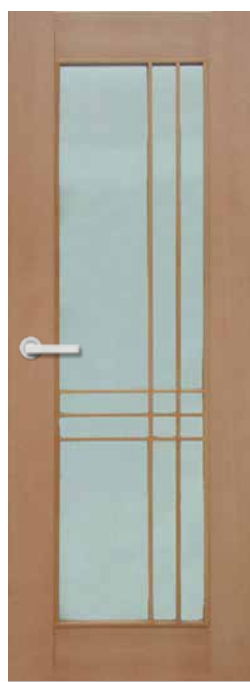

8141
面料 | 木皮 原色上油
| 直紋紅櫟 PH091
| 配砂片玻璃



8164
面料 | 木皮 原色上油
| 紅櫟白沙比利
| 配清片玻璃



8147
面料 | 淨色焗漆
| 清片加彩砂玻璃



3324
面料 | 耐火板
| CW138
| 配灰鏡玻璃



8131
面料 | 木皮 原色上油
| 德國榆木PB227
| 配黑油玻璃·平窗線



8139
面料 | 木皮 原色上油
| 直紋胡桃 PH181
| 配清片玻璃



8166

面料 | 木皮 原色上油
| 魁北克白杏木 索B394色
| 配砂片玻璃



8133

面料 | 木皮 原色上油
| 巴西胡桃PA101
| 配清片玻璃



8105

面料 | 木皮 索近似B394色
| 直紋胡桃 PH181
| 配清片玻璃



8101

面料 | 木皮 索近似B394色
| 直紋胡桃 PH181
| 配清片玻璃



8132

面料 | 木皮 索近似B394色
| 直紋胡桃 PH181
| 配清片玻璃



8169

面料 | 木皮 原色上油
| 直紋胡桃 PH181
| 配清片玻璃



8131

面料 | 淨色焗漆 黑油(全啞)
| 配砂片玻璃



8300

面料 | 淨色焗漆 黑油(全啞)
| 配灰玻·平窗線



3304

面料 | 耐火板
| B398
| 6mm銀色鋁條



3333

面料 | 耐火板
| YF3880拼YF3865
| 配黑色不鏽鋼條



3335

面料 | 耐火板
| YF3880
| 配不鏽鋼鏡



3329

面料 | 耐火板
| YF3880拼YF1178
| 配不鏽鋼條



3334

面料 | 耐火板
| YC3304拼YC5344
| 配黑色不鏽鋼條



3325

面料 | 耐火板
| CW146
| 6mm銀色鋁條



3343

面料 | 耐火板
| DH327拼花



3326

面料 | 耐火板
| YC3106
| 配不鏽鋼條



3336

面料 | 耐火板
| YF3830
| 配不鏽鋼鏡



3095

面料 | 耐火板
| YF3508
| 5mm U坑上近似色油

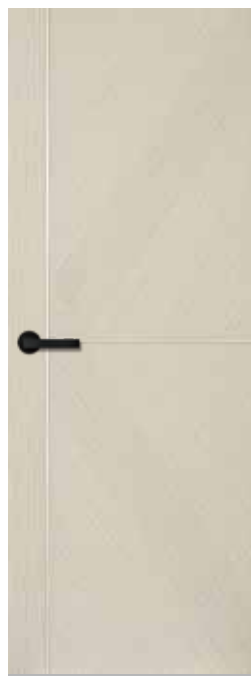

3318

面料 | 耐火板
| YD3857
| 6mm銀色鋁條

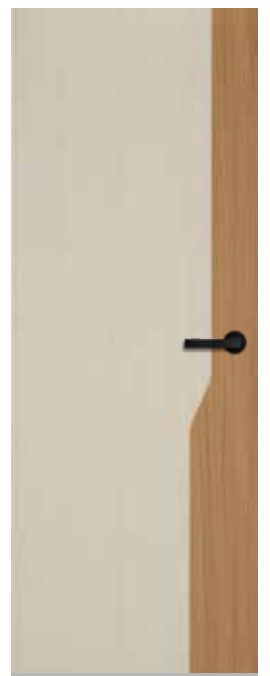

3328

面料 | 耐火板
| YF3830拼YF3292
| 5mm U坑上近似色油



3316

面料 | 耐火板
| YC3107
| 5mm U坑上近似色油



3345

面料 | 耐火板
| DH310拼D751



3353

面料 | 耐火板
| DH310拼D750



3338

面料 | 耐火板
| DH310
| 6mm拉絲鋁條



3314
面料 | 耐火板
| FA14
| 6mm拉絲鋁條

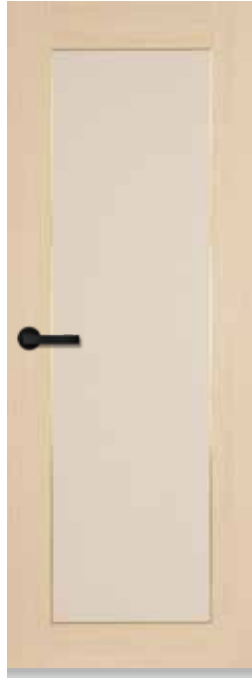

3334
面料 | 耐火板
| YC3303拼YC5343
| 配金色不鏽鋼條

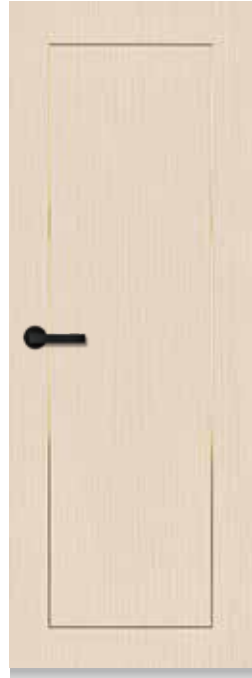

3326
面料 | 耐火板
| YC3181
| 配金色不鏽鋼條



3332
面料 | 耐火板
| YF3276
| 配金色不鏽鋼條



3319
面料 | 耐火板
| YC3168
| 歐式門款



3342
面料 | 耐火板
| YB3109



3318
面料 | 耐火板
| CW39
| 6mm銀色鋁條



3337
面料 | 耐火板
| CW117
| 5mm U坑上近似色油



3311
面料 | 耐火板
| YF3881



3341
面料 | 耐火板
| YB3109



3343
面料 | 耐火板
| G414



3095
面料 | 耐火板
| YF3877
| 5mm U坑上近似色油



3336
面料 | 耐火板
| CW98
| 配不鏽鋼鏡



3315
面料 | 耐火板
| YD3633
| 5mm U坑上近似色油



3331
面料 | 耐火板
| YF3865
| 配黑色不鏽鋼條



3335
面料 | 耐火板
| YF3865
| 配不鏽鋼鏡



3348

面料 | 耐火板
| YF3878



3344

面料 | 耐火板
| YC5349拼YF3878



3320

面料 | 耐火板
| YD3852
| 6mm拉絲鋁條



3325

面料 | 耐火板
| CW95
| 6mm銀色鋁條



3316

面料 | 耐火板
| YC3108
| 5mm U坑上近似色油



3315

面料 | 耐火板
| YC3108
| 5mm U坑上近似色油



3349

面料 | 耐火板
| DH199拼DH307



3319

面料 | 耐火板
| YD3856
| 歐式門款



1601
面料 | 木皮 原色上油
| 日本薰衣草 PC321



3070
面料 | 木皮 原色上油
| 日本薰衣草 PC321
| 5mm U坑上近似色油



1506
面料 | 木皮 原色上油
| 紅櫟白沙比利



1503
面料 | 木皮 原色上油
| 紅櫟白沙比利



1600
面料 | 木皮 原色上油
| 法國白杏木 PC309



1011
面料 | 木皮 原色上油
| 比利時白橡 PA106



1525
面料 | 木皮 原色上油
| 比利時白橡 PA106
| 配幼紋黑絲線 PA118



1207
面料 | 木皮 原色上油
| 芬蘭白橡 PA102
| 配德國紅橡 PB228



1209
面料 | 木皮 原色上油
| 芬蘭白橡 PA102



1208
面料 | 木皮 原色上油
| 芬蘭白橡 PA102



1007
面料 | 木皮 原色上油
| 德國紅橡 PB228



1210
面料 | 木皮 原色上油
| 德國紅橡 PB228
| 拼芬蘭白橡 PA102
| 配幼紋黑絲線 PA118



1522
面料 | 木皮拼花 原色上油
| 德國榆木 PB227
| 配幼紋黑絲線 PA118



1600
面料 | 木皮 原色上油
| 意大利胡桃 PB204



1525
面料 | 木皮 原色上油
| 德國榆木 PB227
| 配幼紋黑絲 PA118



1519A
面料 | 木皮 原色上油
| 幼紋灰橡 PB214
| 配幼紋黑絲線 PA118

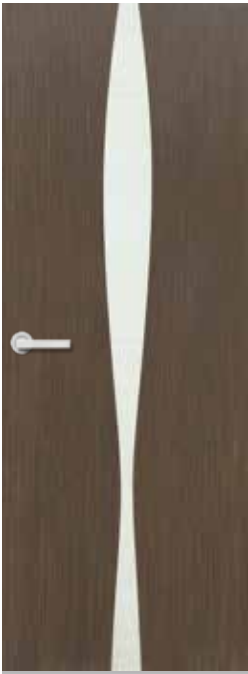

1516
面料 | 木皮 原色上油
| 德國胡桃 PC320
| 配日本薰衣草 PC321



1524
面料 | 木皮 原色上油
| 德國薰衣草 PC322
| 配幼紋黑絲線 PA118



1518
面料 | 木皮 原色上油
| 德國榆木 PB227
| 配日本薰衣草 PC321



1511
面料 | 木皮 原色上油
| 德國薰衣草 PC322



1515
面料 | 木皮 原色上油
| 德國薰衣草 PC322
| 拼日本薰衣草 PC321
| 配幼紋黑絲 PA118



1523
面料 | 木皮 原色上油
| 德國薰衣草 PC322
| 配幼紋黑絲線 PA118



1520
面料 | 木皮 原色上油
| 德國榆木 PB227
| 配幼紋黑絲線 PA118



3092
面料 | 木皮 原色上油
| 日本薰衣草 PC321
| 5mm U坑上近似色油



3090

面料 | 木皮 原色上油
| 法國白杏木 PC309
| 5mm U坑上近似色



4102

面料 | 木皮 原色上油
| 芬蘭白橡 PA102
| 5mm U坑上近似色



3093

面料 | 木皮 原色上油
| 芬蘭白橡 PA102
| 5mm U坑上近似色



3312

面料 | 木皮 原色上油
| 比利時白橡 PA106
| 5mm U坑上近似色



3094

面料 | 木皮 原色上油
| 林肯淺胡桃 PA113
| 配不鏽鋼鏡
| 5mm U坑上近似色油



3026

面料 | 木皮 原色上油
| 德國紅橡 PB228
| 配合金飾條



4046

面料 | 木皮 原色上油
| 德國紅橡 PB228



3065

面料 | 木皮 原色上油
| 直紋沙比利 PH111
| 13mm V坑貼木皮



4044

面料 | 木皮 索近似G484色
| 德國紅橡 PB229
| 12mmV坑



4016

面料 | 木皮
| 巴西胡桃 PA101
| 5mm U坑上近似色



4040

面料 | 胡桃木皮 索B394色
| 5mm U坑上近似色



6065

面料 | 木皮 索B394色
| 金絲袖



3042Y

面料 | 木皮 原色上油
| 幼紋薰衣草 PA115
| 配6mm鋁條
| 5mm U坑上近似色



3041

面料 | 木皮 原色上油
| 幼紋薰衣草 PA115
| 橫紋5mm U坑上近似色油

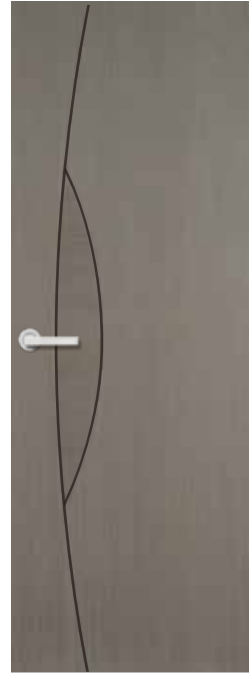

3092

面料 | 木皮 原色上油
| 幼紋薰衣草 PA115
| 5mm U坑上近似色



3049

面料 | 木皮 原色上油
| 幼紋薰衣草 PA115
| 5mm U坑上近似色



3098
面料 | 木皮 原色上油
| 德國薰衣草 PC322
| 5mm U坑上近似色油



3095
面料 | 木皮 原色上油
| 德國胡桃 PC320
| 5mm U坑上近似色油



3085
面料 | 木皮 原色上油
| 德國胡桃 PC320
| 5mm U坑上近似色油



3066
面料 | 木皮 索近似B394色
| 幼紋胡桃 PA111
| 13mm V坑貼木皮



4104
面料 | 木皮 原色上油
| 德國胡桃 PC320
| 12mmV坑



6045
面料 | 木皮 原色上油
| 比利時白橡 PA106



5100
面料 | 木皮 原色上油
| 法國銀橡 PC305



6046B
面料 | 木皮 原色上油
| 直紋幼紋銀橡 PC311
| 中間木皮直紋



6062
面料 | 木皮 原色上油
| 幼紋白楓 PA112



6064
面料 | 木皮 原色上油
| 櫟木



6038
面料 | 木皮 原色上油
| 芬蘭白橡 PA102



6036
面料 | 木皮 原色上油
| 芬蘭白橡 PA102



3037
面料 | 木皮 原色上油
| 直紋楓木



2017
面料 | 木皮 原色上油
| 直紋紅櫟 PH091



2003
面料 | 木皮 原色上油
| 直紋紅櫟 PH091



4033
面料 | 木皮 原色上油
| 秋香木 PB210



2070

面料 | 木皮 原色上油
| 直紋紅櫟 PH091



5025

面料 | 木皮 原色上油
| 芬蘭白橡 PA102



6053

面料 | 木皮 原色上油
| 秋香木 PB210



6066

面料 | 木皮 原色上油
| 德國紅橡 PB228



6031

面料 | 木皮 原色上油
| 直紋紅櫟 PH151



6079

面料 | 木皮 原色上油
| 德國紅橡 PB228



6028

面料 | 木皮 原色上油
| 德國紅橡 PB228



4036

面料 | 木皮 原色上油
| 德國紅橡 PB228



4056

面料 | 木皮 原色上油
| 瑞士藍莓 PB223
| 12mmV坑



6038

面料 | 木皮 原色上油
| 林肯淺胡桃



6017

面料 | 木皮 原色上油
| 胡桃 索B394色



4103

面料 | 木皮 原色上油
| 林肯淺胡桃 PA113
| 12mmV坑



6057

面料 | 木皮 索PA111色
| 幼紋胡桃



4055

面料 | 木皮 索近似B394色
| 沙比利 PH111
| 12mmV坑

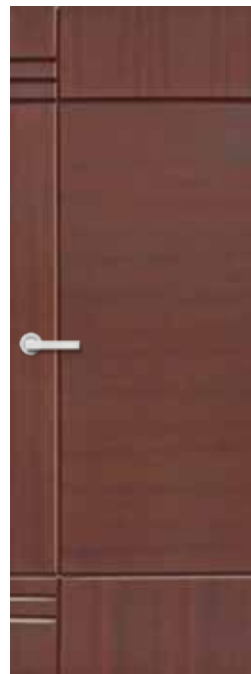

4045

面料 | 木皮 索近似B389色
| 直紋沙比利 PH111
| 12mmV坑



6061

面料 | 木皮 索近似B389色
| 山紋紅橡 PH152



3004
面料 | 木皮 原色上油
| 直紋沙比利 PH111



6039
面料 | 木皮 原色上油
| 意大利胡桃 PB204



6072
面料 | 木皮 索近似B389色
| 直紋沙比利 PH111



T3037
面料 | 木皮 原色上油
| 瑞士紅櫻桃 PB217

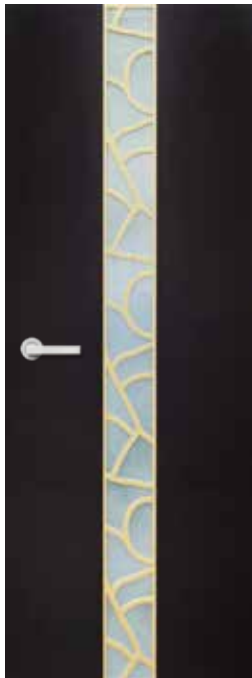

3076
面料 | DH357配DH111
| 配金油通花



3501
面料 | 實木 PN16色油
| 浮雕芬蘭松木



3505
面料 | 實木 PN16色油
| 浮雕芬蘭松木
| 鑼坑不做凸線



3509
面料 | 實木 PN16色油
| 浮雕芬蘭松木
| 鑼坑不做凸線

門鎖 LEVER HANDLES

黑色牛角鎖



銀色牛角鎖



尺寸

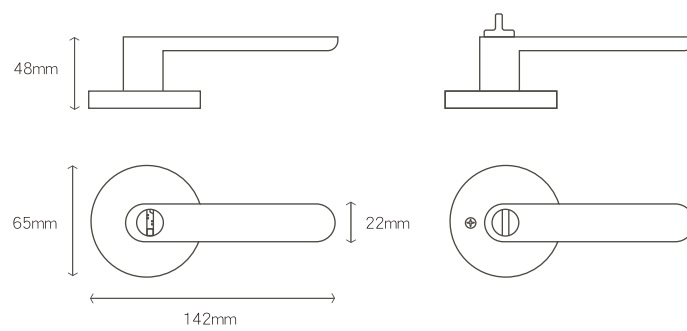

門框 FRAMES

門框主要用作固定及保護木門，避免木門受到碰撞或損壞。傳統木門都會配一套門框，前後加起來為之一套。門框主要材料為木材，分為實木心、夾板心或中纖板心，一般會按照木門的款式配對。

實木門框指整個門框都以木枋刨成，因直接以刀在原木上刨出紋理，所以可以造成各種雕花、波浪等形狀，但實木一般顏色比木皮更深，可能會與木門有些許色差。夾板心門框指的是以木皮包裹門框外側，但複雜的雕花部份仍然以實木取代，所以表面看起來與實木門框差不多。中纖板心門框多用於焗漆款式，其表面光滑，便於裝飾加工及上漆。

意大利木皮門框 · 封口線 PA106 # A3 · C01





	A1	B1
	實木花邊門框	木皮環保花邊門框



	A2	B2
	實木凸肚邊門框	木皮環保凸肚邊門框



	A3	B3
	實木方邊門框	木皮環保方邊門框



	A4	B4
	實木斜邊門框	木皮環保斜邊門框



	A5	B5
	實木圓角邊門框	木皮環保圓角邊門框

封口線 MOULDINGS

封口線的作用是遮蓋傳統的門框與牆身之間的接駁位，主要作為粉飾。傳統做法的推拉門若配了門框，大多會配一套封口線，使室內空間看起來更美觀。封口線同樣可分為實木線、夾板線及中纖板線，主要按木門及門框的材質配對成一套，也可按客人的喜好或要求配對其他顏色。以素白的牆身配以素白的門框及封口線，配襯胡桃色的木門或其他木紋質感豐富的木門，更能提高室內裝潢的觀賞性。

除了一般的封口線外，選用耐火板作為面料的德利門可配套免釘封口線，生產周期更短，安裝更方便，而且耐火板本身的材質堅硬，能提供很優秀的保護性能。

實木封口線 栓木 # C05





*可選實木款或環保木皮款

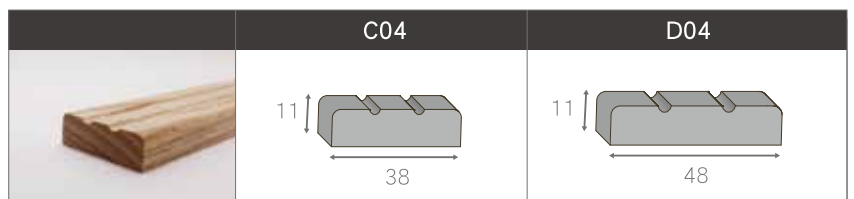
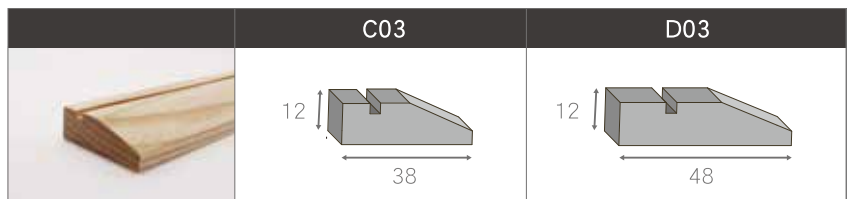
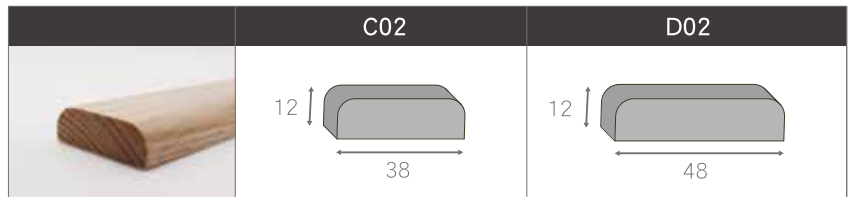
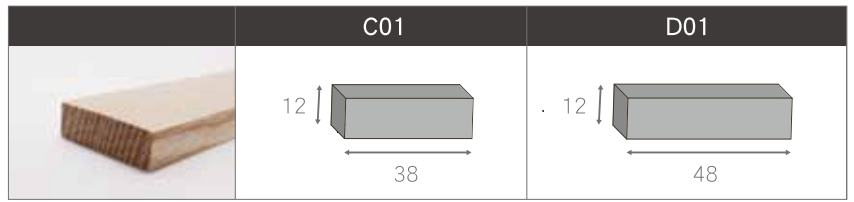

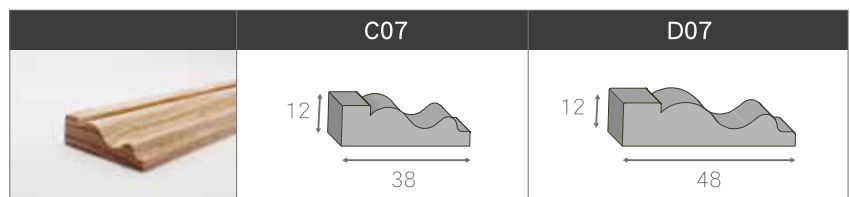
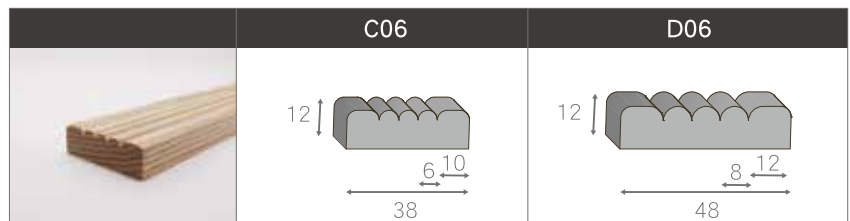
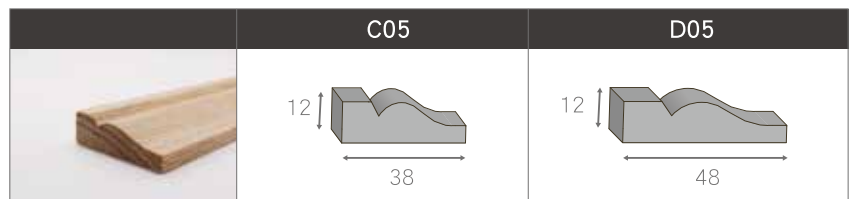
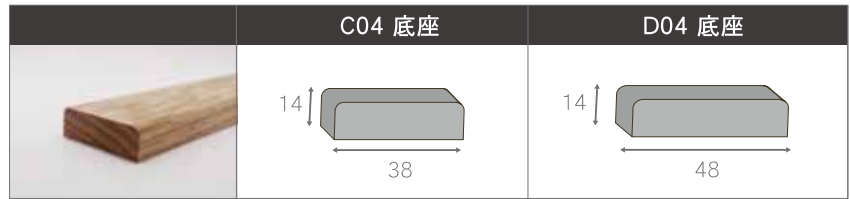

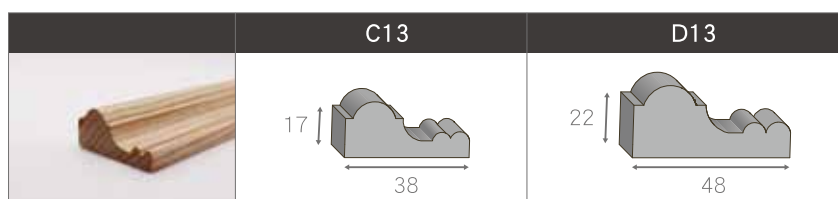
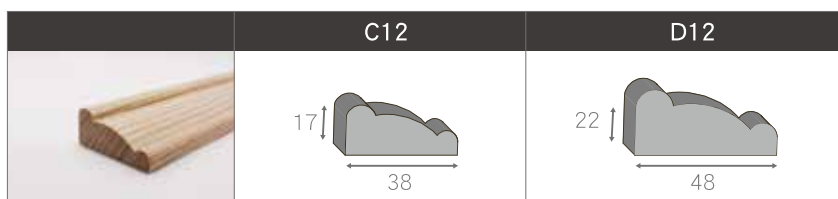
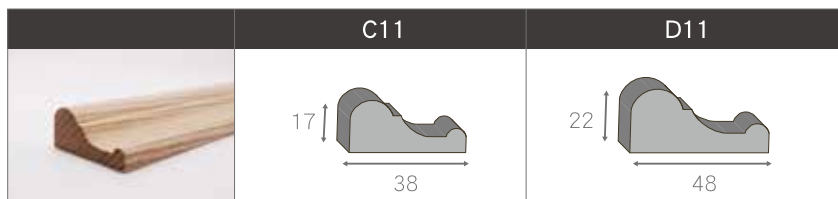

C04款封口線配4個底座

底座尺寸：14mm x 38mm x 130mm

D04款封口線配4個底座

底座尺寸：14mm x 48mm x 130mm

超靜鋁趟門 SLIDING DOORS

#D186
AL507M 耐火板 · DH328橫紋





D174
AL507B
耐火板 · DH326
配黑油玻璃



D176
AL507B
耐火板 · DH307
配D756



D177
AL507B
耐火板 · YF3879橫紋
配黑油玻璃



D178
AL507M
耐火板 · DH515
配YF3372



D180
AL507M
耐火板 · YF3878橫紋
配D258



D181
AL507W
DH329配DH103



D185
AL507W
YF3344配CG505



D186
AL507M
耐火板 · DH328橫紋



D187
AL507W
CG217 橫紋
配超白白油玻璃



平面款
AL507M
配鏡 背暗橫



D188
AL570
耐火板 · PH311 配楓葉玻璃



D183
AL570
耐火板 · DH362配C415



D183
AL570
耐火板 · D750配DH333



D183
AL530
耐火板 · YF3876



D183
AL570
耐火板 · D312 橫紋



D5007
AL501B
木皮·法國薰衣草
PC317 山紋



D5002
AL530
耐火板·FA25



D5001
AL530
木皮·魁北克白杏木
PC303 山紋



D129
AL501M
木皮·西班牙松木
PB218 橫紋



D5014
AL501B
耐火板·YB1828/YD3708

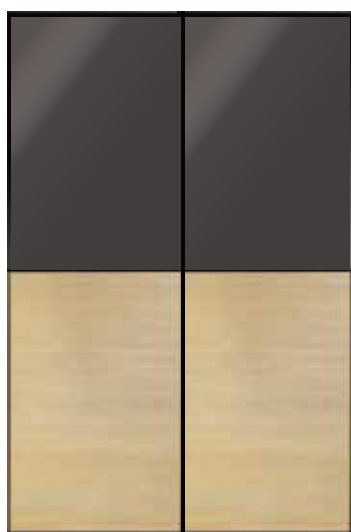

D5004
AL505B
耐火板·YD3812 橫紋 配黑油玻璃



D5006
AL501M
PA115 幼紋薰衣草 直紋 配灰鏡



D5016
AL505B
耐火板·YC3717 配黑鏡



D5005
AL503D
YD5805 配超白白油砂玻璃

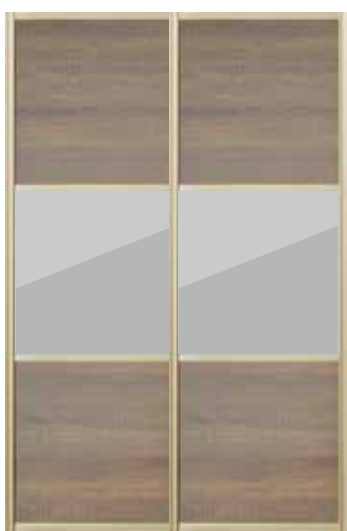

D5003
AL503D
耐火板·YD3175 橫紋 配灰玻



D5011
AL502M
耐火板·FA20 橫紋

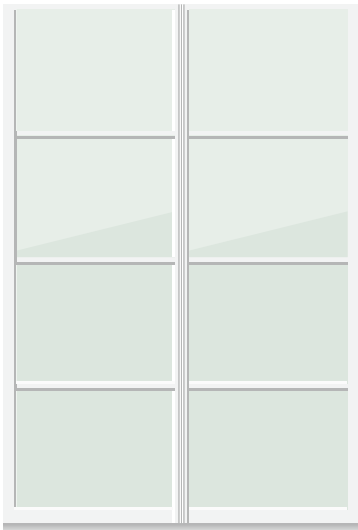

D123
AL501W
單面藥砂

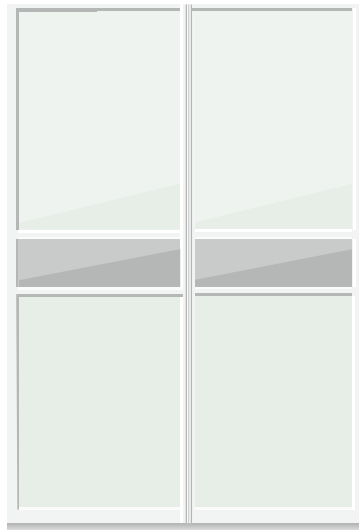

D125
AL501W
灰鏡



D002
AL501S
B395配CG111

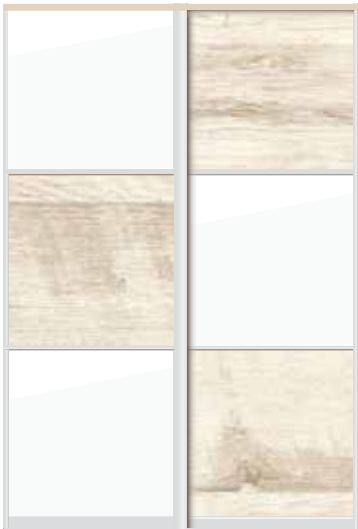

D097
AL502
超白白油玻璃配CW69 橫紋

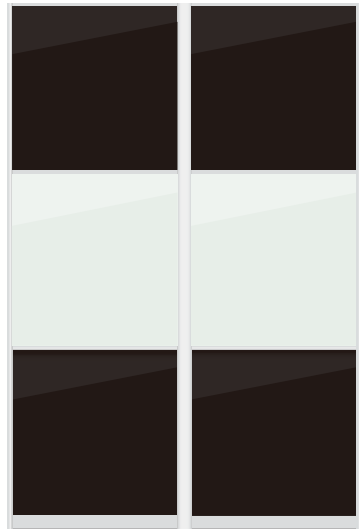

D013
AL502
黑油玻璃配白油玻璃



D122
AL501
B394 超白白油玻璃

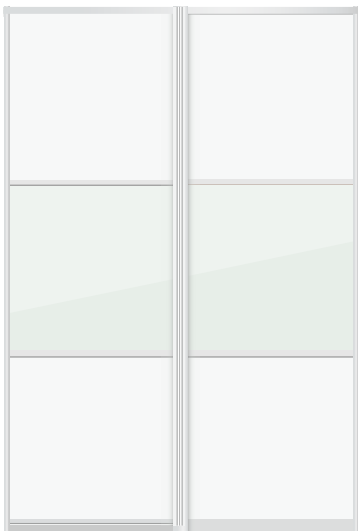

D140
AL505
E231 配白油玻璃



D5013
AL503D
超白白油玻璃 / 茶鏡



D5008
AL503D
耐火板 · YD3851 橫紋 茶玻



D070
AL501
灰鏡底 面配磨砂玻璃



D150
AL502
TL301 + PV103
配鏡片



D149
AL505
腰位白油通花板
配黑油玻璃



D156
AL501B
CW98 灰鏡

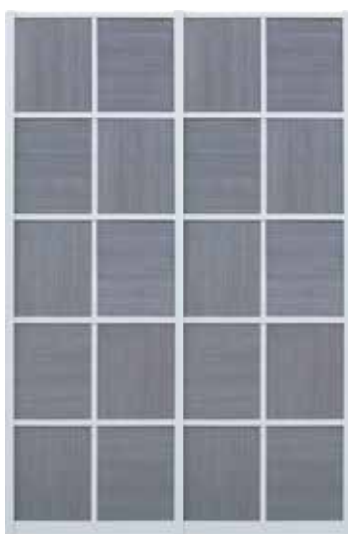

D157
AL501
CW98 橫紋 / CW98 直紋

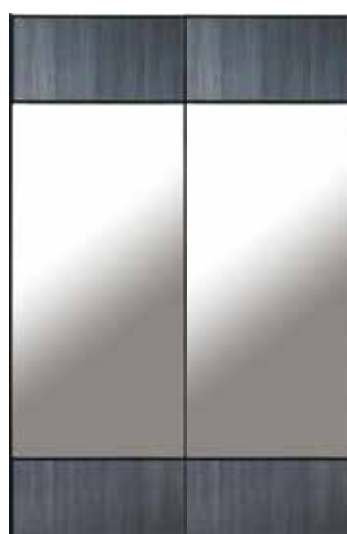

D5015
AL505B
耐火板 · YB3608 配鏡片



D3040
鋁框 · AL501W
超白彩印安全玻璃



D4002
鋁框 · AL501W
超白彩印安全玻璃

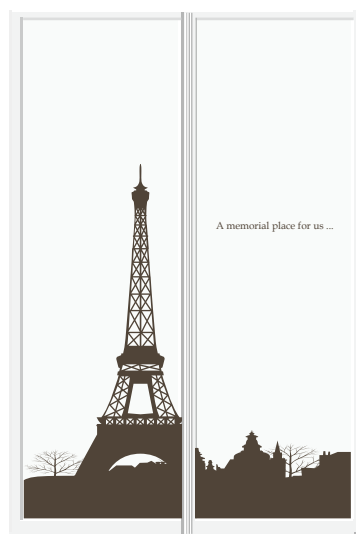

D4003
鋁框 · AL501W
超白彩印安全玻璃



D4022
鋁框 · AL501W
超白彩印安全玻璃



D4005
鋁框 · AL501W
超白彩印安全玻璃

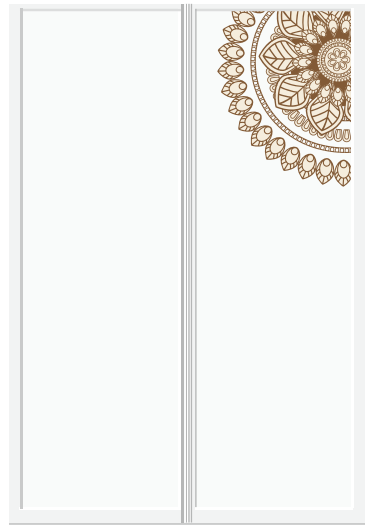

D4006
鋁框 · AL501W
超白彩印安全玻璃



D4007
鋁框 · AL501W
超白彩印安全玻璃



D4008
鋁框 · AL501W
超白彩印安全玻璃



D4009
鋁框 · AL501W
超白彩印安全玻璃

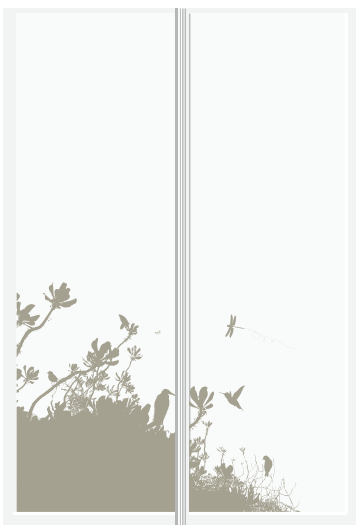

D4013
鋁框 · AL501W
超白彩印安全玻璃

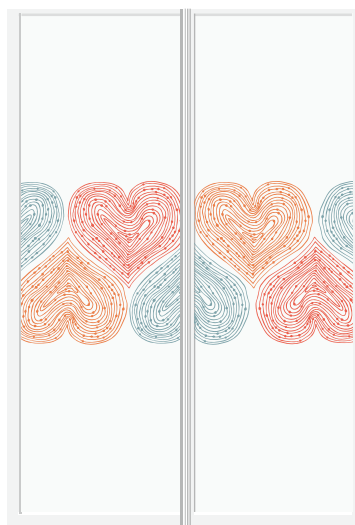

D4011
鋁框 · AL501W
超白彩印安全玻璃



D4010
鋁框 · AL501W
超白彩印安全玻璃



D4012
鋁框 · AL501W
超白彩印安全玻璃



D4014
鋁框 · AL501W
超白彩印安全玻璃

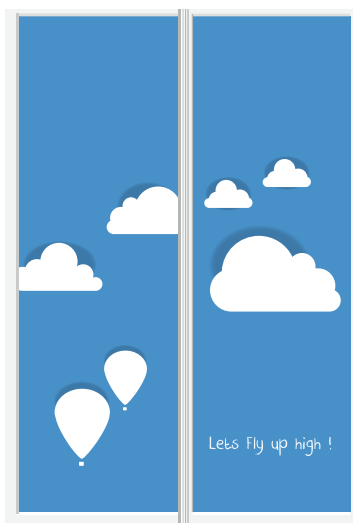

D4015
鋁框 · AL501W
超白彩印安全玻璃



D4016
鋁框 · AL501W
超白彩印安全玻璃



D4017
鋁框 · AL501W
超白彩印安全玻璃



D4018
鋁框 · AL501W
超白彩印安全玻璃



D4019
鋁框 · AL501W
超白彩印安全玻璃



D4020
鋁框 · AL501W
超白彩印安全玻璃

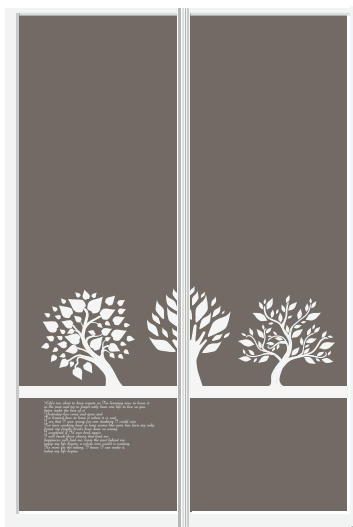

D4004
鋁框 · AL501W
超白彩印安全玻璃

衣櫃趟路及鋁框 TRACKS AND FRAMES



AL501			AL502		
		 40.5 (A面) 9 34.5 40.5 (B面)			 (企柱地) 24 (正面) 14 3 9 34
25			25		

AL505 可配AL505 暗橫		AL507		
 11 (正面) 7 9 34 25 M 啞光 B 光黑	 11 25			
	 15mm 25.2mm	 6 34 17 20	 11 25	 15mm 25.2mm

ALO4 (可轉掛趟門)			
	 15 30 6 30	 16 6 23 46	 15 6 23 70

AL530 無框趟門



超靜鋁趟門	色	每平方米	最低消費
AL530	W / 白色	\$850	1.2m ² (闊度及高度最少以600mm計算)
	M / 啞光		
	B / 光黑		

* 包 A-CW系列膠板或 PA, PB, PC款木皮及防塵毛條。配WA530轆及路軌，另加\$500/隻
 * 趟門厚度34mm只適用於木皮門(1mm木皮封邊)或膠板門(PVC封邊)

AL503



AL503D / 香檳電泳



AL503 企柱

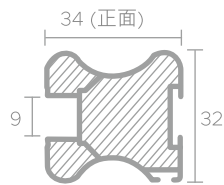

AL503 中橫

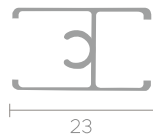

AL506 可配AL506 暗橫

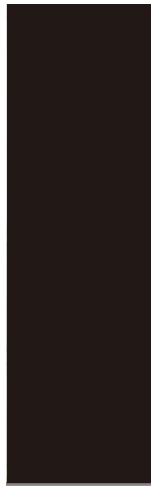

AL506W / 白色



AL506B / 光黑



AL506 企柱

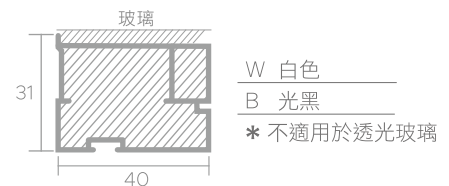

AL506 暗橫



	AL501	AL502	AL503	AL505	AL507	AL04	AL530
上路	BL20	BL20	BL20	BL20	BL20	BL04	BL20
下路	BL25	BL25	BL25	BL26	BL26	BL01	BL25
頂底疏位	40mm	40mm	40mm	40mm	40mm	13mm	40mm
中橫	✓	✓	✓	✓	✓	✓	✗
暗橫	✗	✗	✗	✓	✓	✗	✗
加油壓緩衝器	✓	✓	✓	✓	✓	✗	✓
耐火板	✓	✓	✓	✓	✓	✗	✓
透光玻璃	✓	✓	✓	✓	✗	✓	✗
不透光玻璃	✓	✓	✓	✓	✓	✓	✗

INDEX

1

1007 (PB228).....	28
1011.....	27
1207.....	27
1208.....	28
1209.....	28
1210.....	28
1503.....	27
1506.....	27
1511.....	29
1515.....	29
1516.....	29
1518.....	29
1519A.....	28
1520.....	29
1522.....	28
1523.....	29
1524.....	29
1525 (PA106).....	27
1525 (PB227).....	28
1600 (PC309).....	27
1600 (PB204).....	28
1601.....	27

2

2003.....	33
2014.....	7
2015.....	7
2017 (白油).....	7
2017 (PH091).....	33
2019.....	7
2028.....	7
2030.....	7
2031.....	7
2032.....	7
2049.....	8
2050.....	8
2054.....	8
2070 (白油).....	8
2070 (PH091).....	34
2075.....	8
2076.....	8
2080.....	8
2082.....	8
2083.....	9
2084.....	9
2085.....	9
2086.....	9
2093.....	9
2100.....	9
2105.....	9
2107.....	9
2108.....	10
2110.....	10
2111.....	10
2112.....	10
2113.....	10
2114.....	10
2115.....	10
2116.....	10
2117.....	11
2118.....	11
2124.....	11
2126.....	11

3

3004 (白油).....	11
3004 (PH11).....	36
3009.....	11
3010B.....	11
3019.....	11
3026.....	30
3033.....	12
3037 (白油).....	12
3037.....	33
T3037.....	36
3040.....	15
3041.....	31
3042Y.....	31
3049.....	31
3052.....	15
3053.....	15
3054.....	15
3055.....	15
3065 (白油).....	12
3065.....	30
3066.....	32
3067.....	12
3070.....	27
3075.....	15
3076.....	36
3077.....	12
3078.....	15
3085.....	32
3090.....	30
3092(PC321).....	29
3092(PA115).....	31
3093.....	30
3094 (白油).....	12
3094 (PA113).....	30
3095 (YF3508).....	23
3095 (YF3877).....	25
3095 (PC320).....	32
3098.....	32
3099.....	12
3501 (白油).....	12
3501 (PN16).....	36
3502.....	13
3505 (白油).....	13
3505 (PN16).....	36
3509 (白油).....	13
3509 (PN16).....	36
3512.....	13
3513.....	19
3514.....	13
3515.....	13
3516.....	13
3517.....	19

33

3303	19
3304	22
3305 (D721)	19
3305 (CW135)	19
3311	25
3312	30
3314	24
3315 (YD3633)	25
3315 (YC3108)	26
3316 (YC3107)	23
3316 (YC3108)	26
3318 (YD3857)	23
3318 (CW39)	24
3319 (YC3168)	24
3319 (YD3856)	26
3320	26
3324	20
3325 (CW146)	22
3325 (CW95)	26
3326 (YC3106)	22
3326 (YC3181)	24
3328	23
3329	22
3331	25
3332	24
3333	22
3334 (YC3304)	22
3334 (YC3303)	24
3335 (YF3880)	22
3335 (YF3865)	25
3336 (YF3830)	23
3336 (CW98)	25
3337	24
3338	23
3341	25
3342	24
3343 (DH327)	22
3343 (G414)	25
3344	26
3345	23
3348	26
3349	26
3351	20
3353	23

4

4016	31
4033	33
4036	34
4040	31
4044	31
4045	35
4046	30
4051	13
4052	14
4053	14
4055	35
4056	35
4102	30
4103	35
4104	32

5

5025	34
5034	14
5038	14
5100	32

6

6017	35
6028	34
6031	34
6036	33
6038 (白油)	14
6038 (PA102)	33
6038 (林肯淺胡桃)	35
6039	36
6045	32
6046B	32
6053	14
T6053	34
6054	14
6057	35
6061	35
6062	33
6063	14
6064	33
6065	31
6066	34
6072	36
6079	34

8

8101	21
8105	21
8110	16
8111C	16
8112	15
8117	17
8118	18
8119	18
8120	16
8122	17
8123	16
8128	18
8129	16
8130	19
8131 (PB227)	20
8131 (黑油)	21
8132	21
8133	21
8134	17
8137	18
8139	20
8140	20
8141	20
8146	17
8147	20
8148 (白油)	16
8148 (PA102)	19
8154	17
8164	20
8166	21
8169 (白油)	17
8169	21
8170	19
8199	16
8200	16
8201	18
8218	17
8219	17
8221	18
8300	18
8300	21
8302	18

