

2021 . 0 7

德利板 **Toppal**[®]

超越E0級低甲醛 99.9%抗菌技術

www.toppal.com





Laminate #DH504 / 斜拼牆身板 CHEVRON



耐火板

淨色及花紋	平板耐火板 1.0mm (1220 x 2440mm)	可屈曲耐火板 0.7mm (1220 x 2440mm)	平板耐火板 0.8mm (1220 x 2440mm)
EA01	—	—	\$210
A、E	\$250	\$250	—
F、G	\$270	\$270	—
FA	—	—	\$250
B	\$290	\$290	—
C、CW	\$310	\$310	—
D、DH	\$330	\$330	—
SA	\$480	—	—
SP (5mm 夾板底)	\$700	—	—

金屬面	平板耐火板 1.0mm (1220 x 2440mm)	可屈曲耐火板 0.7mm (1220 x 2440mm)	平板耐火板 0.8mm (1220 x 2440mm)
M801	\$380	—	—
M800、M805、M806	\$550	\$550	—
M808、M816、M822	\$650	\$650	—
M881、*M890 (0.6mm)	\$800	—	—

* 只限車邊收貨，驗貨後不作退換

其他	平板耐火板 1.0mm (1220 x 2440mm)	可屈曲耐火板 0.7mm (1220 x 2440mm)	平板耐火板 0.8mm (1220 x 2440mm)
RA199 黑色實驗室防腐蝕耐火板 (0.7mm) (1220mm x 2440mm)	—	\$650	—
A100C, A101C, B301C, E231C F421C 及 H 全色實心 (1.0mm)	\$700	—	—
SC 對紋全色實心	\$900	—	—

EO 抗菌啞白膠板 (免費跟送)	AE07 (0.7mm)	AE10 (1.0mm)
	\$78	\$115

彩晶板 (不能與萬能膠使用)	每件 (1220 x 2440 x 2mm)	半件 (610 x 2440 x 2mm)
*CY104 - CY139	\$700	\$400

* 只限車邊收貨，驗貨後不作退換

**規格及價目如有更改，恕不另行通知



淨味無臭強力白膠

容量	價格
300g	\$30/支

* 適用於所有PVC邊、ABS邊、彩晶邊、壓克力邊封邊，彩晶板壓貼。

PVC / ABS 封邊條

闊度 23mm		闊度 43 - 52mm	
K001 - K017	\$3/米	KY101 - KY198	\$12/米
K101 - K112	\$5/米	KY206 - KY291	\$16/米
K137 - K198	\$6/米	KY405 - KY406	\$25/米
K206 - K299	\$6/米	KY411 - KY487	\$12/米
K405 - K407	\$10/米	KY501	\$60 15米/卷
K411 - K499	\$6/米	KY521 - KY523	\$10/米
K501 - K505	\$60 30米/卷	KY660 - KY666	\$12/米
K521 - K523	\$4/米	KY705 - KY722	\$12/米
K660 - K666	\$5/米	KY809	\$30/米
K701 - K729	\$4/米	KHY101 - KHY520	\$12/米
K808	\$18/米	KSY	\$12/米
KH101 - KH529	\$6/米		
KS	\$6/米		

Remarks & Delivery Terms / 送貨條款及注意事項

- 耐火板 / 彩晶板 / 木皮夾板
(送鋪) 訂購1件或以上，免費送貨。
(送地址) 訂購2件或以上，免費送貨。訂購1件，送貨每單另加\$10。
- 其他現貨產品 (送鋪/地址) 訂購\$500或以上，免費送貨。\$500以下每單另加 \$50運費。
- 送貨只包一程升降機，不作轉升降機及樓梯搬運。
- 耐火板收貨起計21天內如無損壞及塗鴉，退貨須每件收取\$50手續費，換貨須每件收取\$30手續費。
- 全色耐火板、彩晶板、木皮夾板、木皮及封邊條，驗收後不作退換。
- K280, K284, K285, K405, K406, K808 不能用萬能膠，只能用PVC強力膠

**規格及價目如有更改，恕不另行通知



Veneer# PC309

意大利木皮系列

	* 木皮耐火板 (1220 X 2440 X 1.2mm)		* 木皮夾板 (1220 X 2440 X 3mm)	8吋木皮 (附不織布底) (203 x 2440 x 0.5mm)	24吋木皮 (附不織布底) (610 x 2440 x 0.5mm)
PA	LA	\$450/件	\$250/件	\$25/件	\$67/件
PB	LB	\$475/件	\$265/件	\$28/件	\$75/件
PC	LC	\$500/件	\$280/件	\$31/件	\$83/件
上油(另加)	已包上油		\$250/件	\$120/件(須用兩件木皮)	\$220/件(須用兩件木皮)

* LA, LB 及LC 耐火板價錢只限耐火板樣辦書上之現貨型號。其他木皮型號加工成耐火板須另行報價

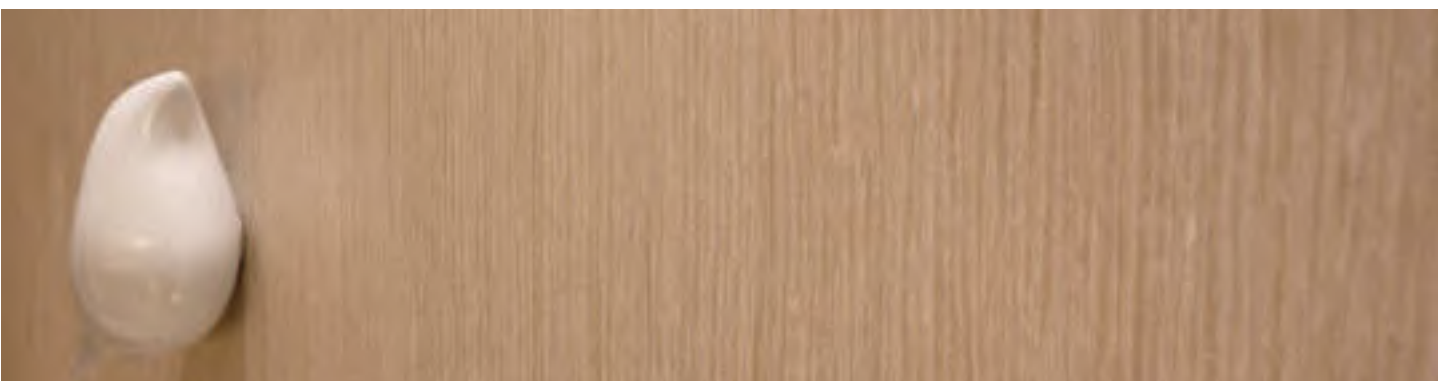



耐火板門板全面採用E0級大芯夾板製造，並經過歐盟BSEN 717-3 甲醛釋放量測試

耐火板面啞白底	每平方米	最低消費
淨色 (A、E、EA)	\$730	0.1m ² (闊度及高度最少以150mm計算)
花式及木紋 (B、C、D、F、FA、G、CW、DH)	\$780	
SA 石紋	\$1000	0.2m ² (闊度及高度最少以150mm計算)
意大利木皮耐火板 (LA、LB、LC)，彩晶板 (CY104 - CY139)	\$1100	
金屬面 (M)，耐火板拼花	\$1250	
金屬面 (M881)	\$1350	

* 如訂購耐火板門板選配任何德利鉸，可免費開同等數量標準鉸孔

* **客戶憑發票及送貨單，可獲十年免費保養。**(不包含安裝及拆除)

有關保養條款，請向各分銷商查詢。

嵌入式手抽



平口斜抽	價格
ABS / 水晶封邊	\$30/邊

* 不適用於耐火板邊

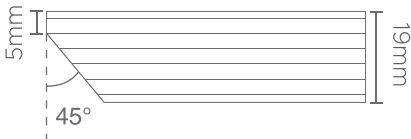

Remarks 訂貨需知

1. 如門板做挖抽，並須對紋或開鉸時，請於圖紙上註明方向，否則以公司出貨為準。
2. 手指坑口及斜口挖抽手須註明抽手長度。



手指坑抽	價格
自訂長度	\$60/邊

* 不適用於耐火板邊



斜口挖抽	價格
ABS封邊	\$150/邊

* 200mm以上，每100mm另收\$15
* 不適用於水晶邊及耐火板邊

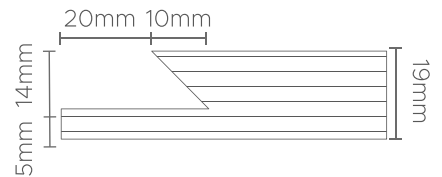

門脰	
淨色及花紋耐火板 (7mm x 38mm)	\$1/吋
金屬及天然木皮耐火板 (7mm x 38mm)	\$2/吋
彩晶板 (8mm x 38mm)	\$2/吋

Remarks & Delivery Terms / 送貨條款及注意事項

1. 門板訂貨滿\$2000或以上免費送貨，\$2000以下另加 \$50運費。
2. 加開1吋3分鉸孔，標準尺寸(上下中位90mm)\$5/個，其他指定尺寸\$10/個。
3. 如需做對紋或指定山紋方向請在落單時註明，否則以公司出貨為準。
(對紋長度過2400mm/對紋闊度過1200mm/不同闊度/高度對紋另加10%)
4. 櫃門板與訂購呎吋相差兩毫米或以下，恕不退貨。
5. 門板高度過2440mm，駁板手工另加15%。
6. 客戶於報價單蓋章或簽名後，如須更改內容將另加收費。

**規格及價目如有更改，恕不另行通知

歐式門板

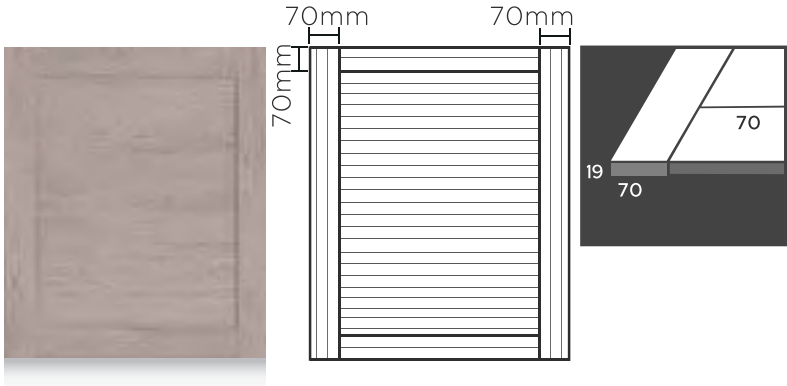

每平方米	最低消費
\$1000	0.2m ² *闊度最少250mm，高度最少200mm

- * 價錢已包雙面貼耐火板及四邊1mm PVC封邊條
- 歐式門板只能做方邊，須雙面貼耐火板
- 只限配1mm封邊（不適用於2mm封邊或耐火板邊）
- 高度過1200mm須另配中橫，每支\$40
- 高度兩邊為直紋，中間部份為橫紋/直紋
- 中間部份可免費改其他色號
- 可免費改封邊色號
- 頂橫、底橫及中橫見光70mm，16mm厚，正面見橫紋
- 不適用於M、LA、LB、LC膠板

* 門板中間部份為6mm厚夾板，門板總厚度為19mm



耐火板門板開窗

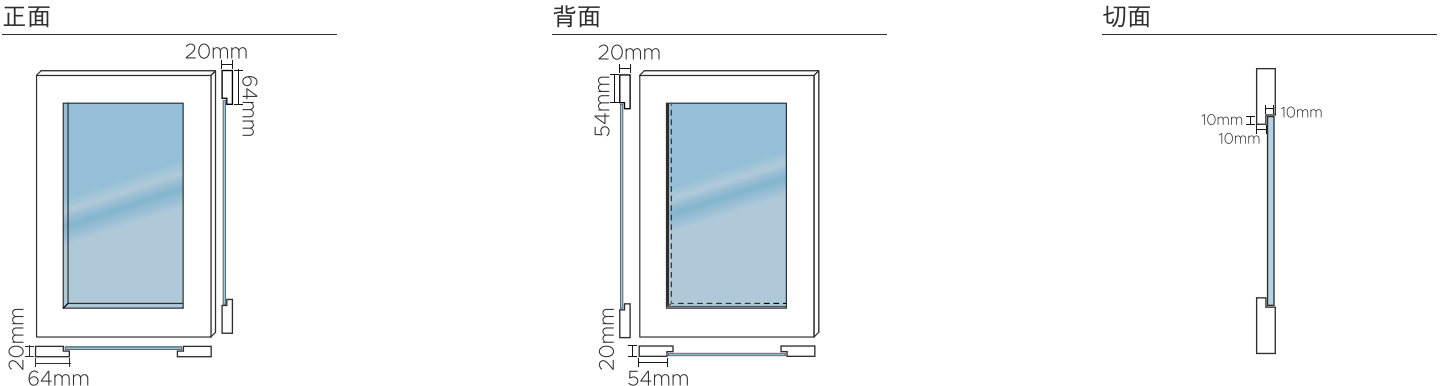

淨開窗孔	耐火板門板開窗			
	不配玻璃	內封PVC封邊條(無止口)	內封PVC封邊條(有止口)	內封KA18鋁邊(有止口)
開窗及配玻璃 (玻璃款式請參考 第8頁淨玻璃分類)	玻璃一	\$160/件	\$200/件	\$220/件
	玻璃二	\$200/件	\$240/件	\$260/件
	玻璃三	\$230/件	\$270/件	\$290/件
	玻璃四	\$260/件	\$300/件	\$320/件
	強化玻璃	\$290/件	\$330/件	\$350/件
		另加\$80/件		

* 四邊邦位見光64mm，如指定尺寸須另加\$20/件

玻璃門板開窗系列 (無止口)

正面

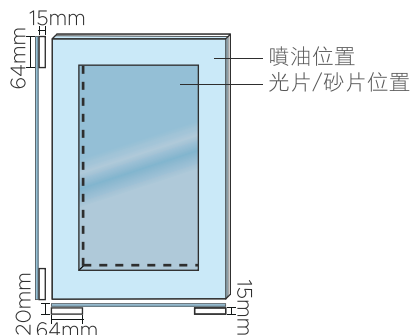

背面

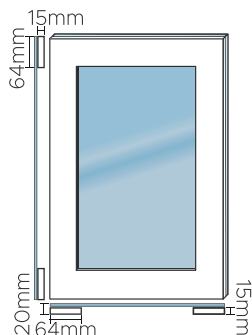

切面

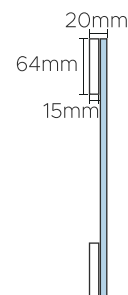

開方孔(無止口)	手工費	內封ABS封邊條	最低消費	玻璃門板 配花式噴油玻璃	中間光片/中間砂片 灰波/黑玻	\$1300/m ²	0.4m ² (闊度及高度 最少以 150mm計算)
		\$150/件	—		強化玻璃 另加	\$200/m ²	

* 四邊邦位見光64mm，如指定尺寸須另加\$20/件

* 門側見玻璃

耐火板門板開孔 (無止口)

開方孔	價格
100mm x 100mm 以內	\$60
200mm x 200mm 以內	\$60
孔內封邊每件	另加\$70

開圓孔	價格
直徑4mm - 6mm	\$15
直徑7mm - 10mm	\$25
直徑11mm - 50mm	\$40
直徑51mm - 200mm	\$60

玻璃門板開孔 (無止口)

開方孔	價格
100mm x 100mm 以內	\$260
200mm x 200mm 以內	\$330
孔內封邊	另加\$70/件

開圓孔	價格
直徑4mm - 6mm	\$30
直徑7mm - 10mm	\$80
直徑11mm - 50mm	\$140
直徑51mm - 200mm	\$260
孔內封邊	另加\$70/件

淨玻璃開孔 (無止口)

開方孔	價格
100mm x 100mm	\$200
200mm x 200mm	\$270

開圓孔	價格
直徑4mm - 6mm	\$15
直徑7mm - 10mm	\$45
直徑11mm - 50mm	\$90
直徑51mm - 200mm	\$180



玻璃夾板門板

玻璃夾板門板 (門側見玻璃)	每平方米	最低消費
鏡片、茶鏡、灰鏡、黑鏡、水晶鏡、黑油、白油、超白白油	\$1100	0.4m ² (闊度及高度 最少以150mm計算)
安全鏡片、白油銀花、黑油銀花、水漾噴彩晶油、超白彩油玻璃		
超白彩晶玻璃(CG101 - CG221)、超白彩印安全玻璃		
超白安全砂玻璃、超白砂片噴白油		

* 價錢已包括四邊PVC封邊



Glass #銀波

淨玻璃

	每平方米	最低消費
玻璃一 茶玻、灰玻、銀波、長虹、單面藥砂、超白清片、超白玻璃	\$350	0.4m ² (闊度及高度 最少以150mm計算)
玻璃二 黑玻、水漾1、清鏡、白油玻璃、冰裂 鏡片、茶鏡、灰鏡、茶砂、灰砂、雙面藥砂	\$420	
玻璃三 水漾2(砂)、銀花玻璃、間條1、黑油、超白白油 黑鏡、水晶鏡、彩砂玻璃、砂底光花、光底砂花	\$490	
玻璃四 白油銀花、黑油銀花、安全鏡片、水漾噴彩晶油、超白彩油玻璃 超白彩晶玻璃(CG101-CG221)、超白彩印安全玻璃	\$560	

* 價錢已包括玻璃磨邊

* 玻璃只限車邊收貨，驗收後不作退換

* 玻璃做斜邊 另加 \$40/米 (按周界計算，每件最低消費1米)

**規格及價目如有更改，恕不另行通知



長虹
鋁框門、鋁趟門
可配鏡底



水漾1
可配色油底
(鋁框門、鋁趟門)



銀波
鋁框門、鋁趟門



水漾2 (砂)
鋁框門、鋁趟門



間條1
鋁框門、鋁趟門



清鏡
夾板門、鋁框門、鋁趟門



灰鏡
夾板門、鋁框門、鋁趟門



黑鏡
夾板門、鋁框門、鋁趟門



茶鏡
夾板門、鋁框門、鋁趟門

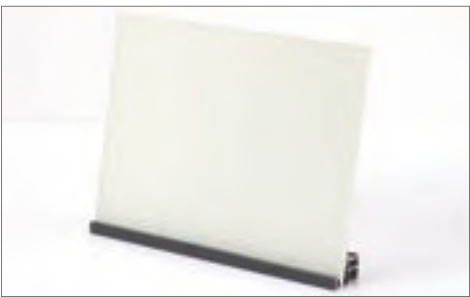

超白白油
夾板門、鋁框門、鋁趟門



紅油(A159色)
夾板門、鋁框門、鋁趟門



超白彩油 (E298色)
夾板門、鋁框門、鋁趟門

(圖片只供參考，玻璃顏色及紋路以實物為準)

	4mm	5mm	6mm	8mm	10mm	12mm	最低消費 0.4m ² (闊度及高度 最少以150mm計算)
清片	\$270	\$270	\$310	\$380	\$430	\$500	
單面藥砂	\$350	\$350	—	—	—	—	
超白玻璃	\$350	\$350	\$390	—	—	—	
水晶鏡	\$490	\$490	\$540	—	—	—	
強化 (另加)	\$200	\$200	\$200	\$250	\$270	\$300	

* 可配安全布底另加\$140/m²

* 每次訂貨少於\$500需另加\$50手續費

**規格及價目如有更改，恕不另行通知

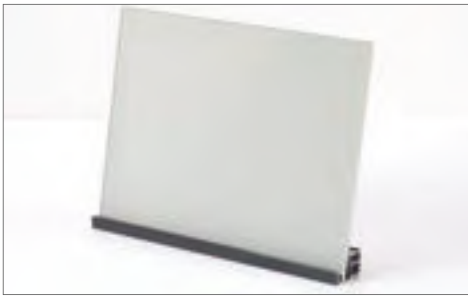

白油
夾板門、鋁框門、鋁趟門



黑油
夾板門、鋁框門、鋁趟門



黑玻
鋁框門、鋁趟門



灰玻
鋁框門、鋁趟門



茶玻
鋁框門、鋁趟門



單面藥砂
鋁框門、鋁趟門



超白砂片
鋁框門、鋁趟門



雙面藥砂
鋁框門、鋁趟門



水漾1 - 噴CY111色
夾板門、鋁框門、鋁趟門



銀花
鋁框門、鋁趟門



白油銀花
夾板門、鋁框門、鋁趟門



黑油銀花
夾板門、鋁框門、鋁趟門

手抽

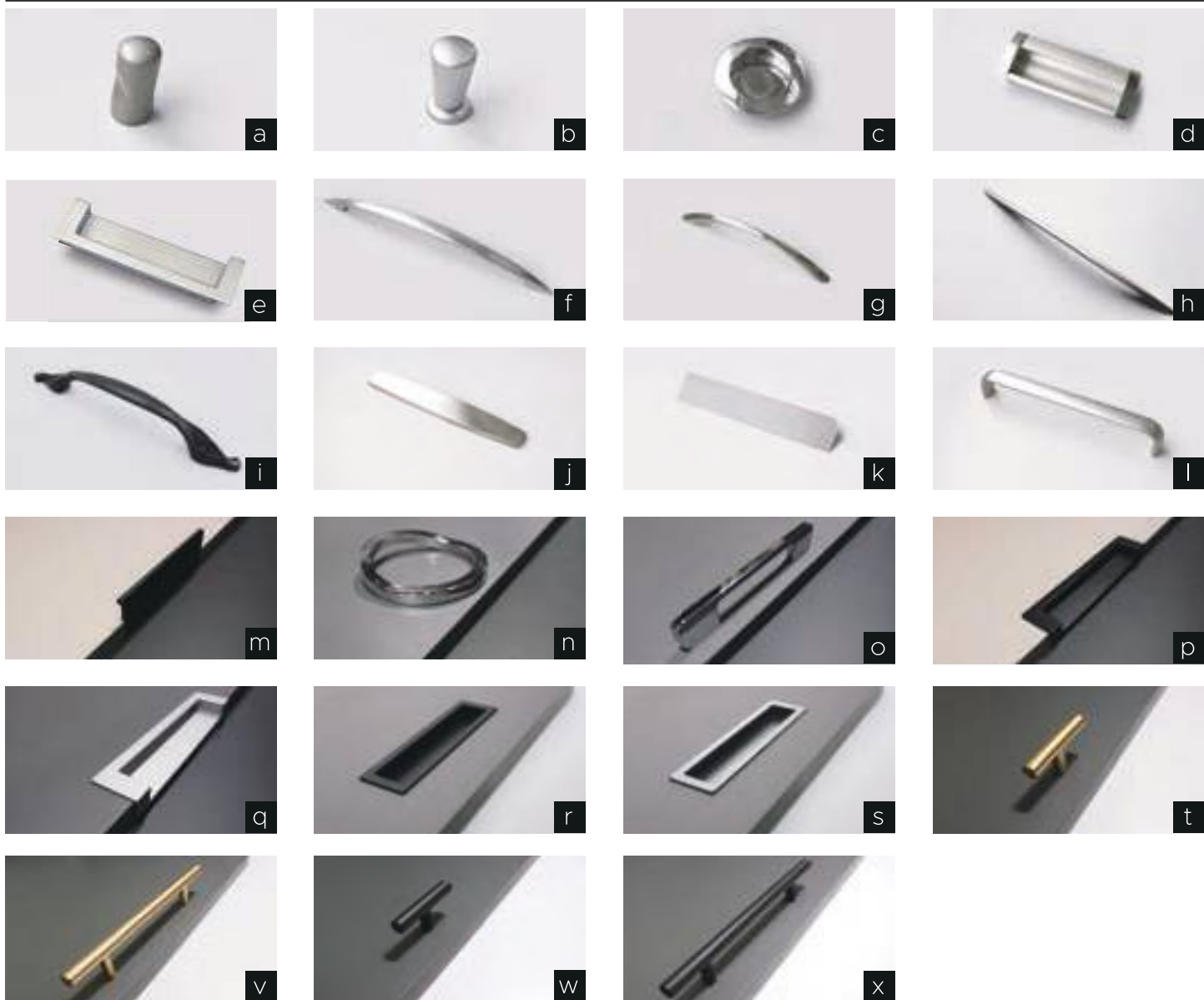

手抽型號	裝工	價格
a CH0140	—	\$5 / 件
b CH0150	—	\$6 / 件
c CH0160	\$12	\$6 / 件
d CH0201 (96mm)	\$20	\$11 / 件
e CH0241 (96mm)	\$20	\$11 / 件
f CH0045 (256mm)	—	\$19 / 件
g	—	CH0171 (96mm) \$7 / 件
		CH0172 (128mm) \$9 / 件
h	—	CH0223 (160mm) \$11 / 件
		CH0224 (192mm) \$13 / 件
i	—	CH0243 (96mm) \$14 / 件
		CH0244 (128mm) \$17 / 件
j	—	CH0033 (160mm) \$13 / 件
k	—	CH0104 (192mm) \$14 / 件

手抽型號	裝工	鑽孔	價格
l	—	—	CH0114 (192mm) \$12 / 件
			CH0115 (256mm) \$14 / 件
m	\$20	—	CH0301 (96mm) \$15 / 件
n	—	\$20	CH0302 (96mm) \$38 / 件
o	—	\$20	CH0303 (128mm) \$45 / 件
p	\$20	—	CH0304 (128mm) \$22 / 件
q	\$20	—	CH0305 (128mm) \$22 / 件
r	\$20	—	CH0306 (128mm) \$38 / 件
s	\$20	—	CH0307 (128mm) \$38 / 件
t	—	\$10	CH0308 \$15 / 件
v	—	\$20	CH0309 (96mm) \$25 / 件
			CH0310 (128mm) \$25 / 件
w	—	\$10	CH0311 \$15 / 件
x	—	\$20	CH0312 (96mm) \$25 / 件
			CH0313 (128mm) \$25 / 件

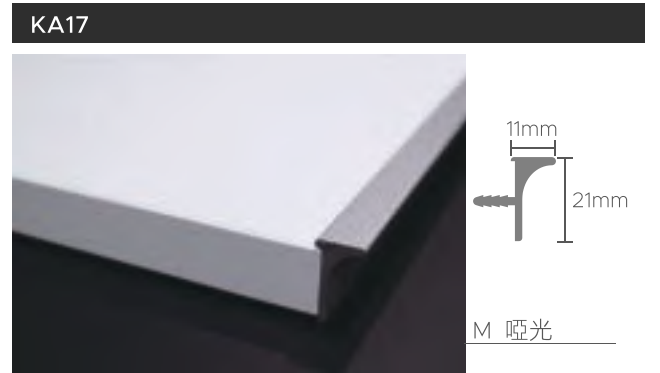
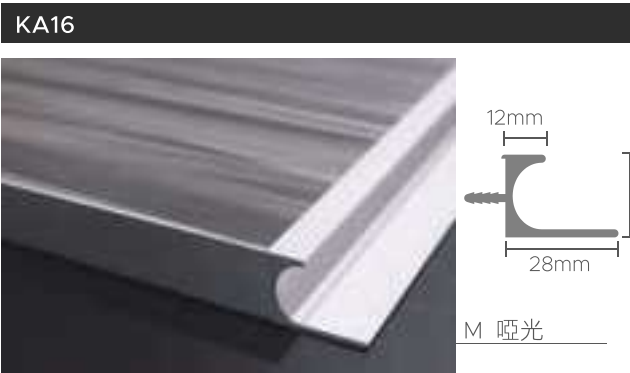
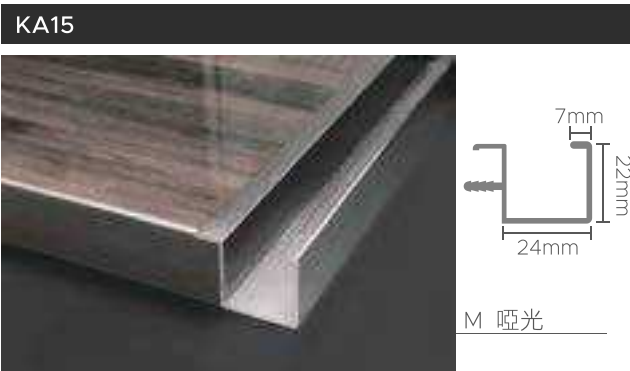

門板封鋁手抽 (1000mm或以下)

KA01/KA05/KA10/KA15/KA16/KA17	\$60/邊
KA19	\$90/邊
KA03 (C/D)	\$80/邊

淨鋁條 (2400mm)

KA01/KA05/KA10/KA15/KA16/KA17/KA03	\$130/支
KA19	\$180/支

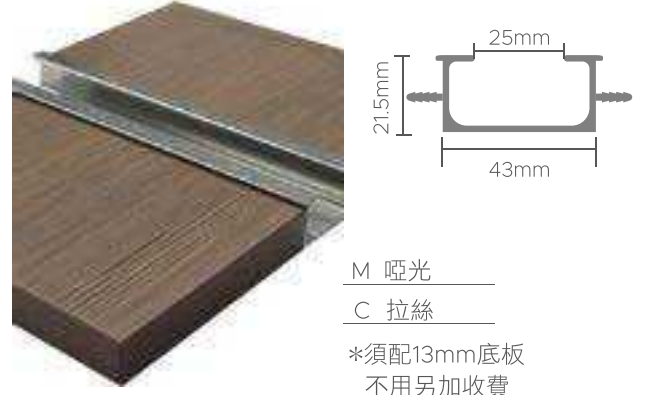

**規格及價目如有更改，恕不另行通知

KA02

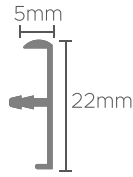

- M 啞光
- S 白金噴砂
- C 拉絲
- G 亮光

KA07

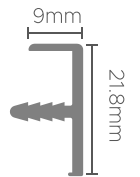
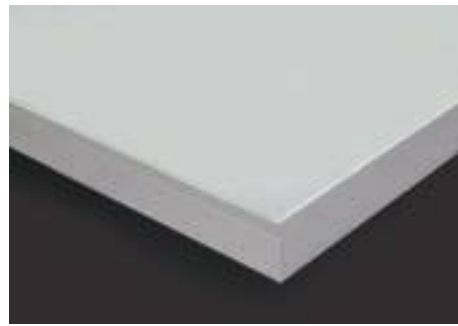

- M 啞光
- S 白金噴砂

KA04

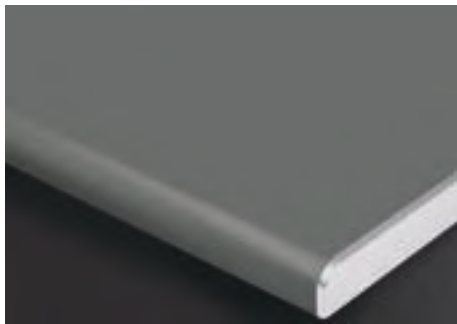

- G 亮光

KA11

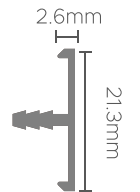

- M 啞光

KA06



- M 啞光
- S 白金噴砂
- C 拉絲
- G 亮光

KA13 - 門板中橫

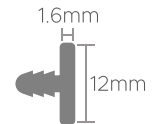

- M 啞光
- C 拉絲
- G 亮光

KA14 - 門板中橫

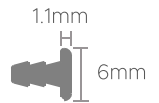

- M 啞光
- C 拉絲
- G 亮光

門板封鋁封邊

KA02/KA06/KA07/KA11	\$50/件
KA04(1000mm或以下/圓邊款)	\$70/邊
KA13/KA14(1000mm或以下)	\$150/支
淨鋁條 (2400mm)	
KA02/KA06/KA07/KA11/KA13/KA14	\$60/支
KA04/KA18	\$130/支

KA18 - 窗內鋁封邊

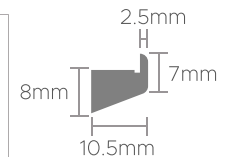

- M 啞光
- G 亮光

(有關門板開窗可見於 P.6)

Remarks & Delivery Terms / 送貨條款及注意事項

-鋁條每張訂單訂貨少於\$500需另加\$50手續費

-鋁條只限車邊收貨，驗收後不作退換

**規格及價目如有更改，恕不另行通知



AL01

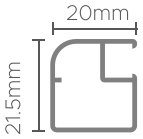

- M 啞光
- K 銀白電泳
- A 香檳噴砂
- S 白金噴砂
- W 白色



AL07

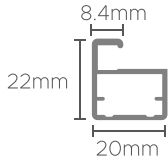

- M 啞光
- S 白金噴砂



AL08

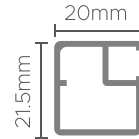

- M 啞光
- S 白金噴砂



KA12手抽

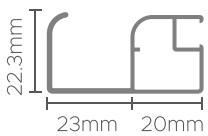

- M 啞光
- S 白金噴砂



KL07手抽

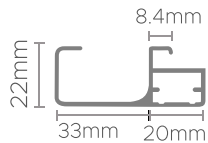

- M 啞光



KL08手抽

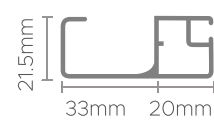

- M 啞光

鋁框門及鋁趟門	每平方米	最低消費
AL01、AL07、AL08	\$600	0.4m ² (闊度及高度 最少以150mm計算)

鋁框配手抽 (1000mm以下)	
KA12、KL07、KL08	\$50/邊

* 包玻璃價目表玻璃一款玻璃(P.8)・110度鉸2隻 或 WA01/WA05 轆1套

* 鋁框門加開鉸孔連鉸 \$15/個, 可另配路軌, 價目請參考第27頁

**規格及價目如有更改, 恕不另行通知



AL03

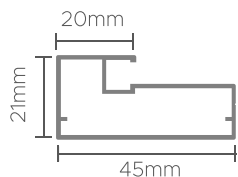

M 啞光



AL06

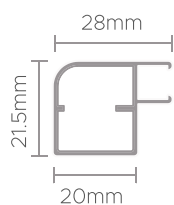

M 啞光

A 香檳噴砂

S 白金噴砂

W 白色

C 拉絲



AL09

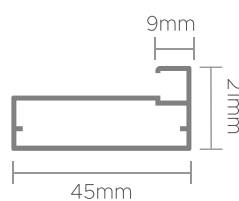

M 啞光

S 白金噴砂

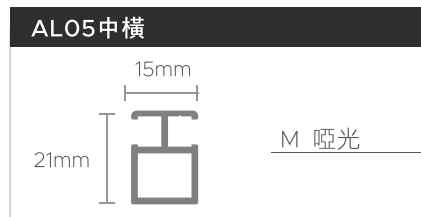

AL05中橫

M 啞光

AL01、AL03、AL06、AL07、AL08、AL09 專用

AL05中橫

\$60/支



CH7011氣撐

CH7011

\$20/件

代鑽螺絲孔另加 \$20/件



KA09手抽

M 啞光

S 白金噴砂

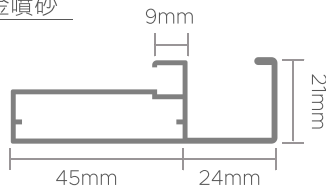

KL09手抽

M 啞光

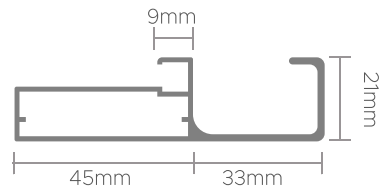



* 不適用於透光玻璃

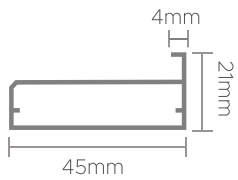

M 啞光
C 不銹鋼拉絲



* 不適用於透光玻璃

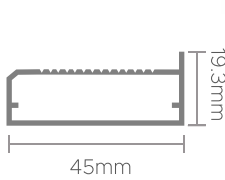

M 啞光
C 不銹鋼拉絲

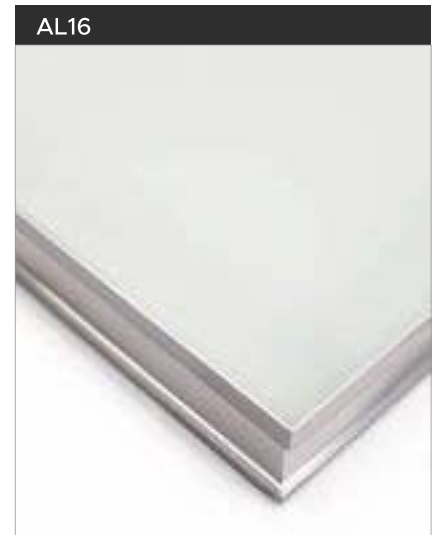

* 不適用於透光玻璃

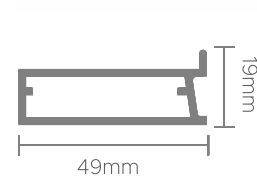

M 啞光
B1 黑色拉絲

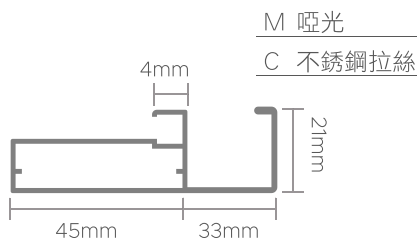

M 啞光
C 不銹鋼拉絲

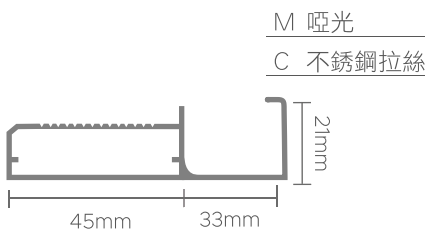

M 啞光
C 不銹鋼拉絲

AL12中橫	
	M 啞光 C 不銹鋼拉絲
AL10專用	
AL12中橫	\$60/支
AL16-1暗橫	
	M 啞光 B1 黑色拉絲
AL16專用	
AL16-1暗橫	\$60/支

鋁框門及鋁趟門	每平方米	最低消費
AL03、AL06、AL09	\$650	0.4m ² (闊度及高度 最少以150mm計算)
AL10	\$900	
AL11	\$1000	
AL16	\$1000	

鋁框配手抽 (1000mm以下)	
KA09、KL09	\$50/邊
KL10	\$60/邊
KL11	\$60/邊

* AL03, AL06, AL09包玻璃價目表玻璃一款玻璃(P.8), 110度鉸2隻。
 * AL10, AL11, AL16包玻璃價目表玻璃二款玻璃(P.8), 110度鉸2隻。(不適用於透光玻璃)
 * 鋁框門加開鉸孔連鉸 \$15/個, 可另配路軌, 請參考第27頁

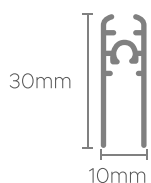

K 銀白電泳

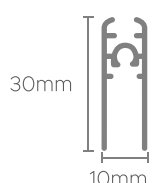

K 銀白電泳

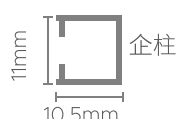

企柱

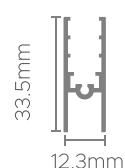

M 啞光

S 白金噴砂

B 光黑

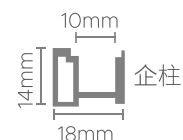

企柱

廚窗薄身趟門	每平方米	最低消費
AL13、AL14	\$650	0.4m ² (闊度及高度 最少以150mm計算)
AL15	\$750	

* 包玻璃價目表玻璃一款玻璃，WA07轆另加\$50/套

* 可另配路軌，價目請參考P.27

	AL13	AL14	AL15
門厚	10mm	11mm	18mm
闊度上限	1000mm	1000mm	1000mm
高度上限	900mm	900mm	1500mm
玻璃厚度	5mm	5mm	5mm

鋁槽坑板

KA80	
2450mm	\$180/支
1225mm	\$100/支



M 啞光

L 藍寶石拉絲

F 檜色拉絲







白磁板

	每件	最低消費
現貨 水筆用光面白磁板 3mm板底 不封邊 * 不包封邊及啞白底 1195mm x 2435mm	\$650	—
現貨 投映用啞白磁板 3mm板底 不封邊 * 不包封邊及啞白底 1215mm x 2435mm		
	每平方米	最低消費
光面白磁板0.25mm厚	\$450	0.4m ²
光面白磁板面 配 3mm-5mm 厚夾板底 * 不包封邊及啞白底 最大尺寸 1197mm x 2435mm	\$500	
光面白磁板面 配 6mm-18mm 厚夾板底 * 不包封邊及啞白底 最大尺寸 1197mm x 4880mm	\$600	
光面白磁板面 配 10mm-19mm 厚夾板底 * 包封邊及啞白底 最大尺寸 1197mm x 2435mm	\$1100	

Remarks & Delivery Terms / 送貨條款及注意事項

1. 磁板訂貨少於\$500需另加\$50手續費
2. 磁板面夾板訂貨滿\$2000或以上免費送貨，\$2000以下送貨須另收運費\$50
3. 磁板只限車邊收貨，驗收後不作退換
4. 只適用於水性白板筆及磁石

仿皮夾心棉

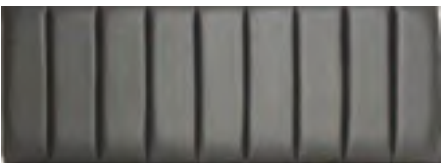
A. 平面方角	B. 花式面 (*只適合淨色人造皮款)	C. 花式面		
				
仿皮夾芯棉 (適用於牆身、椅背及床頭)			每平方米	最低消費
平面方角 (A)			\$650	0.4m ²
平面不規則邊			另加\$100	
花式面 / 自來款 (B, C)			另加\$300	

Remarks & Delivery Terms / 送貨條款及注意事項

1. 以上價錢包厚度 50mm
2. 如須做圓角請註明 R 圓度，不規則邊請提供模辦以供對照
3. 花式面請提供圖紙註明尺寸
4. 床頭板訂貨少於\$500需另加\$50手續費
5. 床頭板訂貨滿\$2000或以上免費送貨，\$2000以下送貨須另收運費\$50
6. 送貨只包一程升降機，不作轉升降機及樓梯搬運

**規格及價目如有更改，恕不另行通知

AL501

AL501 企柱		AL501 中橫
 40.5 (A面) 9 34.5 40.5 (B面)		 25

AL502

	AL502 企柱
	 (企柱地) 24 (正面) 14 3 9 34
	AL502 中橫
	 25

AL505 可配AL505 暗橫

AL505 企柱	 11 (正面) 7 9 M 啞光 B 光黑 34 25
AL505 中橫	 11 25
AL505 暗橫	 15mm 25.2mm

AL507

B / 光黑	M / 啞光	W / 白色
AL507 企柱	AL507 中橫	AL507 暗橫
 6 34 17 20	 11 25	 15mm 25.2mm

AL04 (可轉掛趟門)

M / 啞光	AL04 企柱	AL04 中橫	AL04 頂底橫
	 15 30 6 30	 16 6 23 46	 15 6 23 70

* AL04鋁趟門淨框料 以門框周界及中橫長度計算\$55/米淨框最低消費\$140

無底路鋁趟門	每平方米	最低消費
◆AL04吊趟門可轉掛趟門	\$750	0.6m ²

◆ 包玻璃價目表玻璃二款玻璃(P.8)，中橫2支、WAO2頂底軌

◆ AL04可轉配WAO6掛趟路軌連軸1套：1.5米 \$240/套、2米 \$260/套、2.5米 \$280/套、3米 \$300/套

* 建議闊度最少為600mm，高度最少為1500mm

AL530 無框趟門



超靜音鋁趟門	色	每平方米	最低消費
AL530	W / 白色	\$850	1.2m ² (闊度及高度最少以600mm計算)
	M / 啞光		
	B / 光黑		

- * 包 A-CW系列膠板或 PA, PB, PC款木皮及防塵毛條。配WA530轆及路軌，另加\$500/隻
- * 趟門厚度34mm只適用於木皮門(1mm木皮封邊)或膠板門(PVC封邊)

AL503

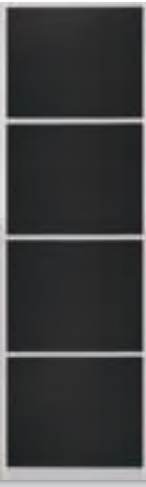

AL503D / 香檳電泳



AL503 企柱

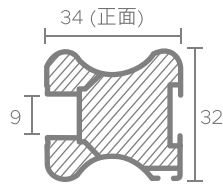

AL503 中橫

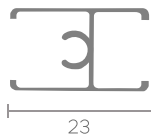

AL506 可配AL506 暗橫



AL506W / 白色



AL506B / 光黑



AL506 企柱

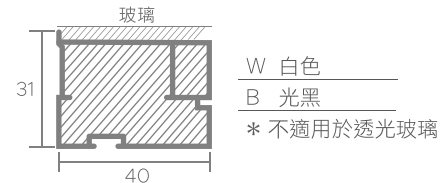

AL506 暗橫



超靜音鋁趟門	每平方米	最低消費
AL501、AL502、AL503、AL505、AL506、AL507	\$750	0.8m ² (闊度及高度 最少以600mm計算)

- * 包玻璃價目表玻璃二款玻璃，或A-DH系列膠板，門側左右防塵毛條、中橫2支、上下轆及路軌
- * 玻璃款式可參照P.8
- * 建議闊度最少為600mm，高度最少為1500mm

**規格及價目如有更改，恕不另行通知

鋁槽坑板 (1220mm x 2440mm)



光身	\$550/件
貼啞白面	\$700/件
貼德利耐火板面	\$600 + 耐火板價錢 / 件
鋁槽(8尺)	\$20/支

* 可改貼天然木皮面及耐火板間色 歡迎查詢
 * 坑板只限車邊收貨，驗收後不作退換

層板 (18mm厚)



	每平方米	最低消費
雙面A119耐火板 四邊封K015	\$480	0.1m ² 闊度及高度最少以150mm計算
雙面啞白膠板 四邊封K501		

* 配其他封邊另加收費

檯面板 (防火板面啞白底)

方形 (四邊磨圓角)

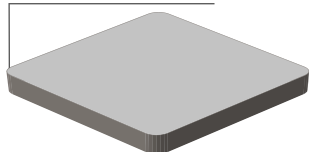

馬肚圓

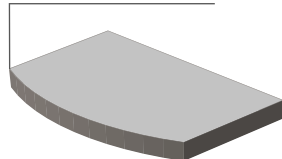

前擋水

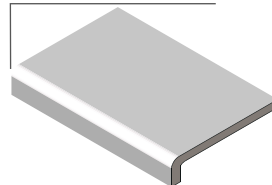

棋子圓 (最少25mm厚)

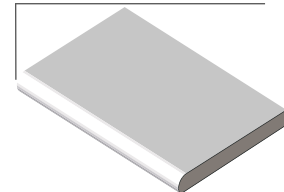

橢圓

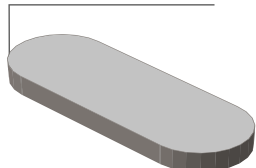

雙邊馬肚圓

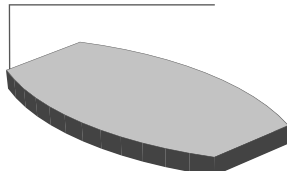

棋子圓後擋水

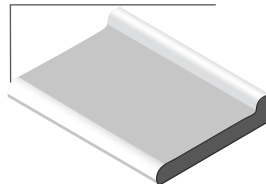

鴨嘴圓 (最少30mm厚)

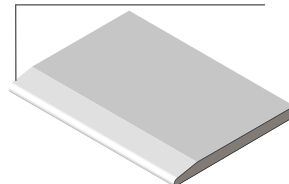

淨色、花式及木紋 (20mm厚) (A、B、C、D、DH、E、EA、F、FA、G、CW款) *價錢已包做方邊或棋子圓，可免費選配PVC闊邊	每平方米	最低消費
	\$780	0.3m ² 闊度及高度最少以150mm計算

形狀	每平方米	最低消費	加厚	每平方米
圓形 / 磨圓角	另加\$350/m ²	0.3m ² 闊度及高度最少以150mm計算	25mm	另加\$80/m ²
橢圓 / 馬肚圓 雙邊馬肚圓	另加\$450/m ²		30mm	另加\$120/m ²
棋子圓後擋水 / 前後擋水 / 前擋水 / 鴨嘴圓	另加\$550/m ²		38mm	另加\$150/m ²
			50mm	另加\$180/m ²

木皮門板 以下價目已包索色費用

	^A款木皮	^B款木皮	^C款木皮	最低消費
四邊1mm木線封邊	\$1000/m ²	\$1050/m ²	\$1100/m ²	每件門板0.2/m ² 門板闊與高最少以150mm計算
四邊5mm木線封邊	另加\$500/m ²	另加\$600/m ²	另加\$700/m ²	
左右5mm木線封邊	另加\$300/m ²	另加\$400/m ²	另加\$500/m ²	
上下1mm木線封邊				
斜口挖抽	另加\$200/個 (≤200mm)			
平口斜抽	另加\$60/邊			

^ 請參閱24-26頁有關木皮款式

* 木皮門板做鋼琴漆另加\$550/m² (只限中纖板底)



* 木皮門板對紋長度超過2400mm 照價加10%

焗漆門板

	光面鋼琴漆	半啞光	最低消費
中纖板底	* \$1380/m ²	* \$880/m ²	每件門板0.2/m ² 門板闊與高最少以150mm計算
斜口挖抽	另加\$300/邊 (200mm以內)	另加\$200/邊 (200mm以內)	
平口斜抽	另加\$80/邊	另加\$50/邊	

* 只限黑白色或樣版書上之色號，其他自來色另加10%

手抽

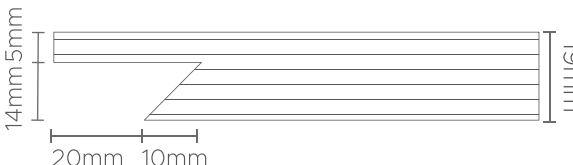
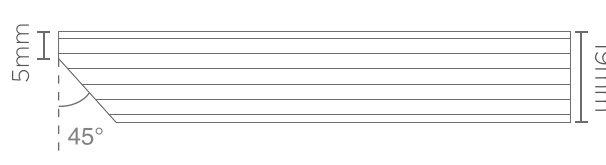
斜口挖抽	平口斜抽
	
	



Veneer #PA101 / 巴西胡桃

實木浮雕櫥櫃門板

	芬蘭松木	栓木	紅橡	最低消費
實木浮雕櫥櫃門板 (白油、PN色油同價)	\$1400/m ²	\$1500/m ²	\$1600/m ²	每件門板0.3/m ² 門板闊與高最少為150mm
開窗 (配5mm清片/ 砂片)	\$250/個			
窗內做彎位	\$150/邊			
窗線	\$120/支(如十字窗當2支計算)			
自訂邦位	\$20/件(標準邦位為64mm)			



WG02



WG06



WG07



WP02



WP03



WP04 (白油)





PA101
Walnut | 巴西胡桃



PA102
White Oak | 芬蘭白橡



PA106
White Oak | 比利時白橡



PA112
Maple Strand | 幼紋白楓



PA113
Light Walnut | 林肯淺胡桃

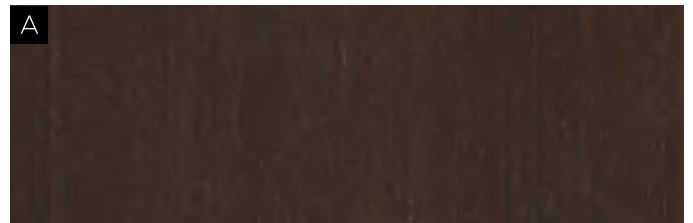

PA114
Dark Wenge | 蘇丹黑鐵



PA115
Lavender | 幼紋薰衣草



PA118
Dark Strand | 幼紋黑絲



PB209
Zebra | 南非斑馬



PB210
Autumn Wood | 秋香木



PB211
Teak | 印尼柚木



PB214
Grey Oak | 幼紋灰橡



PB217
Cherry | 瑞士紅櫻桃



S PB227
Elm | 德國榆木



PB228
Red Oak | 德國紅橡



S PC305
Silver Oak | 法國銀橡



PC309
Ginkgo Biloba | 法國白杏木



S PC311
Finesline Silver Oak | 幼紋銀橡



PC312
Silver Walnut | 銀胡桃



S PC313
Rosewood | 印度花梨

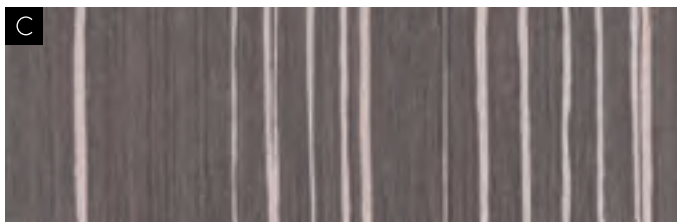

PC316
Walnut | 瑞士胡桃



S PC320
Walnut | 德國胡桃



PC321
Lavender | 日本薰衣草

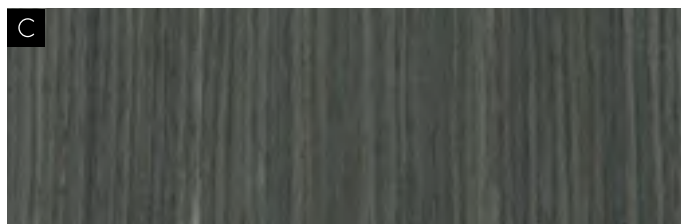

S PC322
Lavender | 德國薰衣草



淨味耐火板貼E0印尼板材 - 單面



美國白橡 直紋
B325

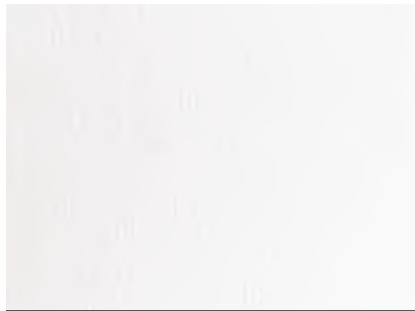

壓紋橡木 直紋
F421



淨色灰色
A119

* 免費提供E0級證書

價錢

6mm	2分 E0 印尼板	\$300/件
12mm	4分 E0 印尼板	\$430/件
18mm	6分 E0 印尼芯	\$470/件

Remarks & Delivery Terms / 送貨條款及注意事項

1. 備有現貨，訂單確認後翌日可安排送貨。別裁另加一個工作天
2. 可代別裁，每刀\$10，別裁後實際呎吋與訂造呎吋±3mm 不作退換
3. 不論送舖或地址，不論件數或有單跟送，每單須另加\$60運費
4. 偏遠地區另加收費
5. 可送上樓，2分每件\$12，4分每件\$20，6分每件\$28，只限有升降機樓層，客人須事先確認升降機大小，如夾板無法進入升降機須改為車邊收貨
6. 收貨後請即場驗收，過後恕不作退換
7. 夾板有少許彎曲，或邊位有少許崩裂，若少於總面積1%為正常現象，恕不退換

趟門配件路軌

WA01	\$20/套	AL01、AL06、AL07、AL08 (鋁框)
	可配搭路軌	頂底疏位 13mm
		頂路軌 BLO3
		底路軌 BLO1
頂底路 \$10/呎		

WA05	\$20/套	AL01、AL06、AL07、AL08 (鋁框)
	可配搭路軌	頂底疏位 8mm
		頂路軌 BLO3
		底路軌 BLO2
頂底路 \$10/呎		

WA02	\$30/套	AL04 (鋁框) 及耐火板門板
	可配搭路軌	頂底疏位 13mm (可調高低)
		頂路軌 BLO4
		底路軌 BLO1
頂底路 \$10/呎		

WA06	淨軫\$220/套	AL04(鋁框) 及耐火板門板
	掛趟路連軫1套	1.5米 \$280
		2米 \$300
		2.5米 \$320
		3米 \$340

WA03	\$20/套	耐火板門板
	可配搭路軌	頂底疏位 8mm (可調高低)
		頂路軌 BLO3
		底路軌 BLO2
頂底路 \$10/呎		

WA07	\$50/套	AL13、AL14 (鋁框)
	可配搭路軌	頂底疏位 17mm
		頂路軌 BLO5
		底路軌 BLO6
頂底路 \$15/呎 (雙路軌)		

WA04	\$30/套	AL03、AL09、AL10、AL11、AL16及耐火板門板
	可配搭路軌	頂底疏位 8mm (可調高低)
		頂路軌 BLO3
		底路軌 BLO2
頂底路 \$10/呎		

WA07	\$50/套	AL15(鋁框)
	可配搭路軌	頂底疏位 17mm
		頂路軌 BLO7
		底路軌 BLO8
頂底路 \$20/呎 (雙路軌)		

BL21-1 定位器	\$10/個

WA530	\$50/套	AL530 (鋁框)
	可配搭路軌	頂底疏位 40mm
		頂路軌 BL20
		底路軌 BL25
頂底路 \$180/米		

趟門配件及路軌

BL01 底路	BL02 底路	BL03 頂路	BL04 頂路
10 11.8	14 9.1	14 9	13 15
BL07 頂路	BL08 底路		
9.5	43.1		
BL05 頂路	BL06 底路		
9.2	25.8		
BL20 頂路	BL25 底路		
45	81.6		
BL20 頂路	BL26 底路		
45	81.6		

WA505	\$40/套	AL505、AL507 (鋁框)
	可配搭路軌	頂底疏位 40mm
		頂路軌 BL20
		底路軌 BL26
頂底路 \$180/米		

WA501	\$40/套	AL501、AL502、AL503、AL506 (鋁框)
	可配搭路軌	頂底疏位 40mm
		頂路軌 BL20
		底路軌 BL25
頂底路 \$180/米		

油壓門鉸系列(2分、4分、6分、內鉸)

110度油壓鉸		165度油壓鉸		110度鋁框油壓鉸	
					
\$11/隻	100隻/箱	\$22/隻	50隻/箱	\$15/隻	100隻/箱

* 如訂購膠板門板選配任何德利鉸，可免費開同等數量標準鉸孔

櫃桶 (底及前後見夾板 其餘位置見啞白)

櫃桶
*請提供櫃實際尺寸

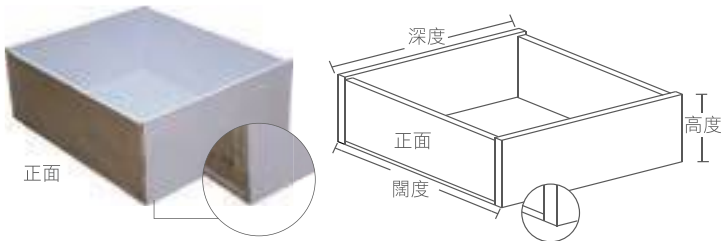

	每平方米	最低消費
4分側板	\$300/m ²	\$210/個
2分底板	\$150/m ²	
手工	\$100/個	

現貨 櫃桶側板 (12mm雙面啞白, 兩邊封白PVC邊)	
300 x 2440 x 12mm	\$160/件
200 x 2440 x 12mm	\$130/件

桶路系列



尺寸	10寸	12寸	14寸	16寸	18寸	20寸	22寸	24寸	26寸	28寸
三節彈壓側路	\$31	\$34	\$37	\$40	\$43	\$46	\$49	\$52	-	-
三節油壓側路	\$31	\$34	\$37	\$40	\$43	\$46	\$49	\$52	\$58	\$61

Remarks & Delivery Terms / 送貨條款及注意事項

1. 門鉸、櫃桶及桶路只接受書面訂購
2. 門鉸、櫃桶及桶路訂貨少於\$500需另加\$50手續費
3. 櫃桶零售價於\$2000或以上免費送貨，不足\$2000 送貨須另收\$50運費
4. 門鉸、櫃桶及桶路送貨，只包一程升降機，不作轉升降機及樓梯搬運

鋁框門、鋁趟門及氣撐 (P.14-16)

	AL01	AL03	AL06	AL07	AL08	AL09	AL10	AL11	AL16
中橫	AL05	AL05	AL05	AL05	AL05	AL05	AL12	—	AL16-1(暗橫)
手抽	KA12	—	—	KL07	KL08	KA09/KL09	KL10	KL11	—
標準鉸孔	90mm	120mm	90mm	90mm	90mm	120mm	120mm	120mm	120mm
一字路(頂路)	BL03	BL03	BL03	BL03	BL03	BL03	—	—	—
一字路(底路)	BL01	BL01	BL01	BL01	BL01	BL01	—	—	—
一字路(轆)	WA01	WA01	WA01	WA01	WA01	WA01	—	—	—
一字路頂位疏位	13mm	13mm	13mm	13mm	13mm	13mm	—	—	—
V字路(頂路)	BL03	BL03	BL03	BL03	BL03	BL03	BL03	BL03	BL03
V字路(底路)	BL02	BL02	BL02	BL02	BL02	BL02	BL02	BL02	BL02
V字路(轆)	WA05	WA04	WA05	WA05	WA05	WA04	WA04	WA04	WA04
V字路頂位疏位	8mm	8mm	8mm	8mm	8mm	8mm	8mm	8mm	8mm
耐火板	✓	✓	✓	✓	✓	✓	✓	✗	✗
透光玻璃	✓	✓	✓	✓	✓	✓	中間透光	中間透光	中間透光
不透光玻璃	✓	✓	✓	✓	✓	✓	✓	✓	✓

超靜鋁趟門 (P.18-19)

	AL501	AL502	AL503	AL505	AL507	AL04	AL530
上路	BL20	BL20	BL20	BL20	BL20	BL04	BL20
下路	BL25	BL25	BL25	BL26	BL26	BL01	BL25
頂底疏位	40mm	40mm	40mm	40mm	40mm	13mm	40mm
中橫	✓	✓	✓	✓	✓	✓	✗
暗橫	✗	✗	✗	✓	✓	✗	✗
加油壓緩衝器	✓	✓	✓	✓	✓	✗	✓
耐火板	✓	✓	✓	✓	✓	✗	✓
透光玻璃	✓	✓	✓	✓	✗	✓	✗
不透光玻璃	✓	✓	✓	✓	✓	✓	✗

耐火板 (P.2)

Characteristics	Standard	Units	
Physical and dimensional properties			
Dimensional stability at high temperature (70°C & 40°C ; 90-95 HR)			
抗高熱 Heat	EN 438-2-17	%	≤ 0.25
抗潮濕 Humidity			≤ 0.1
Mechanical properties			
抗熱水 Resistance to boiling water	EN 438-2-12	Class ^(a)	5
Health and environmental characteristics			
甲醛釋放量 Formaldehyde emission	JIS A 1460	Classification	F☆☆☆☆
有毒物質排放量 Volatile organic compounds(VOC) emission	UL2818	Classification	GREENGUARD GOLD
抗菌 Antibacterial properties	JIS Z 2801	% Reduction	> 99,9

Characteristics	Standard	Units	
Fire performance			
耐火度 Fire rating	BS476-7	Class ^(c)	1
Surface properties			
抗蒸汽 Resistance to steam	EN 438-2-14	Class ^(a)	5
抗熱 Dry heat resistance 180°C (for 20 min)	EN 438-2-16	Class ^(a)	5
抗破裂 Resistance to cracking	EN 438-2-23	Class ^(a)	5
抗刮度 Scratch resistance	EN 438-2-25	Degree ^(b)	4
		N	6N
耐污度 Stain Resistance	EN 438-2-26	Class ^(a)	5
抗強光 Colour fastness under artificial light	EN 438-2-27	Greyscale	4 to 5

(a) Class: 1 = Surface damage. 2 = Severe appearance alteration. 3 = Moderate change. 4 = Slight change visible from certain angles. 5 = No change.

(b) Grade: 2 = Continuous scratches at 2N. 3 = Continuous scratches at 4N.

(c) Class: 1 = damage ≤ 165mm , 2 = damage ≤ 215mm , 3 = damage ≤ 265mm

CERTIFICATIONS & TEST REPORTS

國際認可証書及測試報告



JIS A 1460-2001
Test of Japanese Building Material
Formaldehyde Release (Laminate)
(F☆☆☆☆)
耐火板日本建築用板材
甲醛釋放量測試(F☆☆☆☆)



JIS A 1460-2001
Test of Japanese Building Material
Formaldehyde Release (Plywood)
(F☆☆☆☆)
大芯板日本建築用板材
甲醛釋放量測試(F☆☆☆☆)



JIS Z 2801-2010
Japanese Industrial Standard
Test of Antibacterial Activity
99.9%
日本標準抗菌測試
99.9% 抗菌



BSEN71-3
British EU Standard
Migration of Certain Elements
Safety of toys
歐盟標準重金屬含量檢測
兒童玩具安全等級



BS476-7
British EU Standard
Fire tests on
building materials
Class 1
建築材料耐火測試
一級



BSEN717-3 : 1996
British EU Standard
Determination of
formaldehyde release
Wood-based panel
Class E0
門板甲醛釋放量測試
E0等級



BSEN717-3 : 1996
British EU Standard
Determination of
formaldehyde release
High Pressure Laminate
Class E0
耐火板甲醛釋放量測試
E0等級



ASTM D6007
ASTM Standards
Determination of formaldehyde
concentrations in air
美國加州(CARB)指定測試
甲醛及其他揮發性有機物質排放量
P1等級



Green Guard Certification
Standards for Low-Emitting
Products
Children & School
Gold
室內空氣品質認證(揮發性排放物)
敏感個體，兒童，老人
金級



BSEN 438
British EU Standard
High-pressure
decorative laminates
Determination of the properties
高壓耐火板
特性及性能測試報告



德利板 **Toppal**[®]



www.toppal.com

